

 *Masonite*[®]
the beautiful door™

steel & fiberglass

entry doors

2010

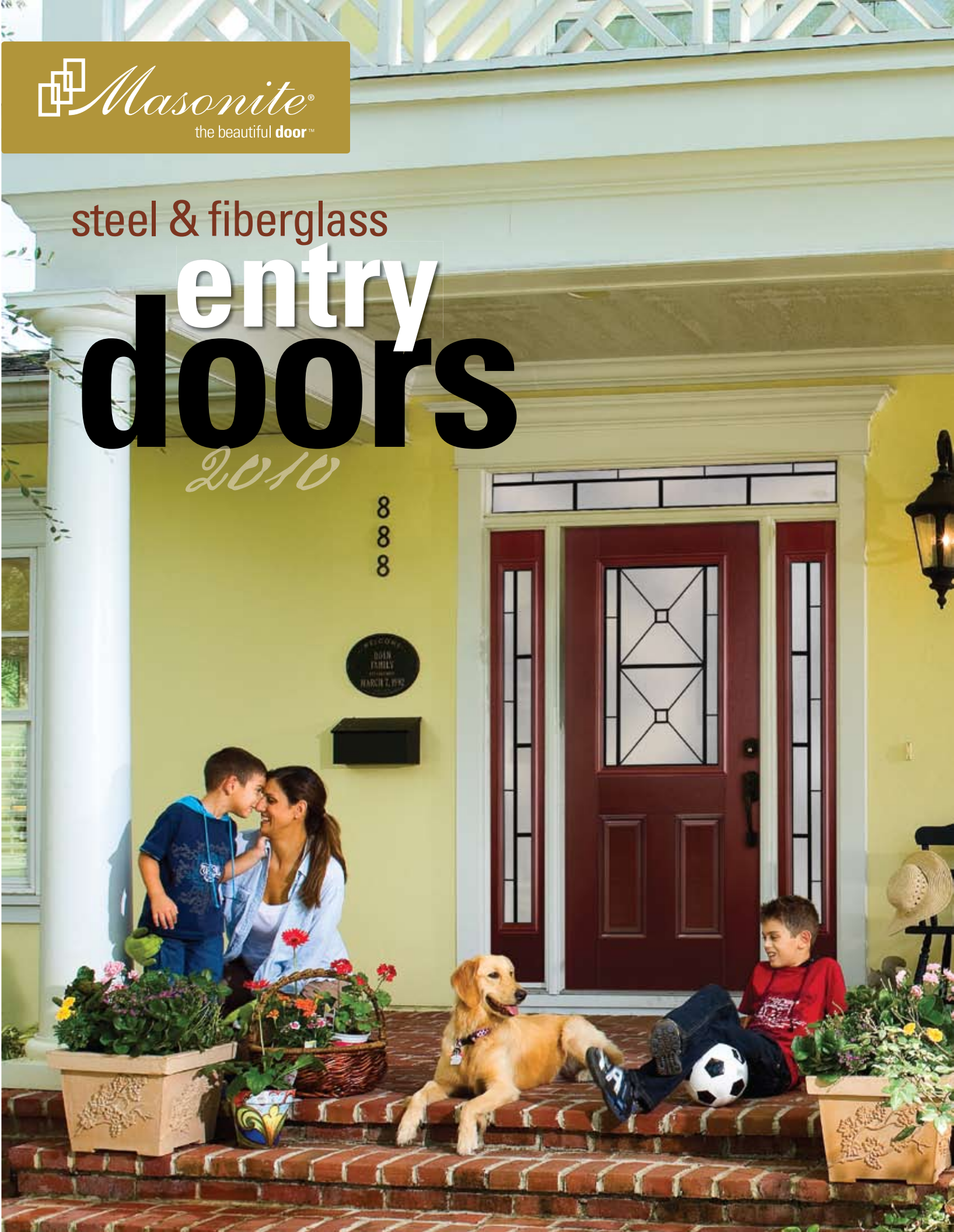



get more

MASONITE® STEEL & FIBERGLASS ENTRY SYSTEMS GIVE YOU MORE

Enhance your curb appeal and add value to your home with a Masonite entryway. Homeowners, architects and builders rely on Masonite for a comprehensive line of beautiful and durable fiberglass and steel entry doors.

This catalog features our extensive line of fiberglass and steel door products shown in a range of panel designs and glass configurations that are sure to meet your architectural style or design need. Make your entryway come to life when you experience our door designer at www.masonite.com.

craftsmanship

BARRINGTON® CRAFTSMAN MAHOGANY TEXTURED BCN/226-SB1-3



MASONITE® HD STEEL AMH/2P



BARRINGTON® FLAGSTAFF™ with AvantGuard™ Spanish Cedar finish BAC-P

BARRINGTON® SIERRA™ with AvantGuard™ Black Walnut finish BAW/2B

BARRINGTON® MAHOGANY TEXTURED with BRZ glass BHM/303-SB1-21

more door designs
more glass styles
more value



BELLEVILLE® OAK TEXTURED with Monor® glass BLT/203-315-7

index

Introduction 2

Masonite® The Brand..... 4

Get Inspired..... 6

How to Choose Your Door..... 8

Masonite's Full Line of Entry Doors..... 10

Masonite® Fiberglass Door Collection

 Barrington®

 Traditional..... 12

 Craftsman..... 18

 Flagstaff™..... 20

 Sierra™..... 20

 AvantGuard™ Finish..... 22

 Belleville®

 Textured..... 26

 Smooth..... 28

 Oakcraft®..... 30

Masonite® HD Steel Door Collection..... 32

Specialty™ Glass..... 34

SDL (Simulated Divided Lite)..... 78

Internal Blinds..... 78

Venting Lites..... 78

Clear Glass..... 78

Entry Systems..... 80

U-Install..... 81

Fast-Frame™..... 82

Entry Systems Rough Openings..... 84

Masonite® Patio & Flush-Glazed Doors..... 86

Masonite® Patio Glass Designs..... 88

Patio Door Rough Openings..... 92

Door Hanging..... 93

ENERGY STAR & Tax Credit..... 94

Door Availability Charts..... 96

Masonite® Stain Kit..... 103

Glass Availability Charts..... 104

Our continuing program of product improvement makes specifications, design and product detail subject to change without notice. Also, due to limitations of the printing process, product images may not match exactly in color to actual product. Masonite reserves the right to make ongoing improvements and changes to existing designs.

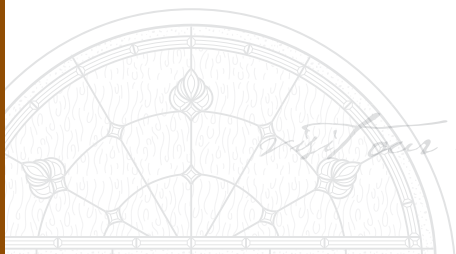

visit our website and explore more solutions...

BARRINGTON® SIERRA™ with Amantiard™ Spanish Cedar finish

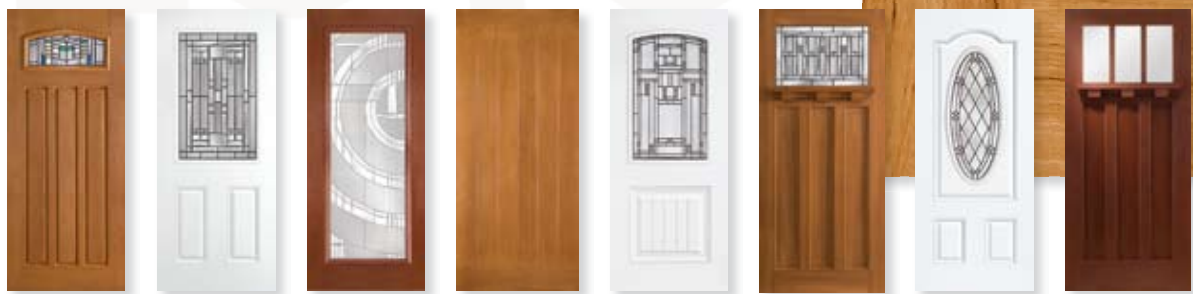

exceptional quality

Brands of Masonite's stature don't just happen. They come from years of dedication and a relentless commitment to improvement. That's why Masonite has one of the world's largest private research and development facilities in the door industry. Masonite owns hundreds of international patents, trademarks and applications.

Through a variety of strategic marketing initiatives, the Company is committed to growing the Masonite brand. Masonite believes that a strong brand will bring value to the products used in homes worldwide and increase the business of its customers. It is for these reasons that Masonite stands as one of the greatest brands within the building products industry.

THE MASONITE BRAND

Since 1925, the Masonite name has been known worldwide for its commitment to product innovation, manufacturing excellence and customer service. These qualities and values are as true today as they were more than 80 years ago.

Masonite is constantly expanding its diverse line of interior and exterior doors to meet any design or budget. By combining the long-standing spirit of innovation with customer-focused product development, Masonite continues to be the brand that builders, remodelers and homeowners rely on in their quest to create homes of distinction.

2010

Today more than ever, Masonite is relentlessly focused on delivering product, service and design innovations that enhance beauty and functionality, creating greater value to our customers throughout the world.



Masonite restructures and emerges with new private ownership. 2009.

April 6, 2005, Kohberg Kravis Roberts & Co. acquires Masonite International Corporation. 2005.

Masonite acquires The Stanley Works residential entry door division. 2004.

Masonite's largest customer and one of the world's leading door manufacturers, Premdor, Inc., acquires Masonite Corporation from International Paper Company. 2001.

Masonite enters the door business as a component supplier to the door industry. 1972.

The John M. Coates Technical Center was built in 1960 as the Company recognized the importance of separating R&D from mill operations to focus on new product and process innovation. 1960.

Masonite's current parent company enters the door business. 1955.

Masonite goes public with common stock shares listed on the New York Stock Exchange. 1935.

The Company's name was changed to Masonite Corporation. 1928.

On September 1, 1925, the corporation was formed and named Mason Fibre Company. 1925.

Well known researcher and engineer – William H. Mason, changed building materials industry forever by inventing the way wood is used to form more effective building materials. 1924.

innovative

1924

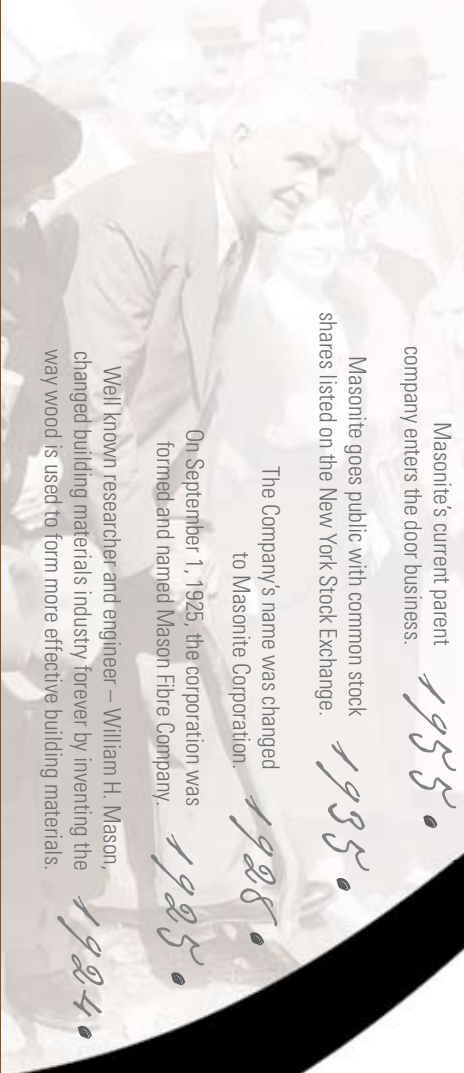

get inspired

Find a door configuration that suits your style or change it up to make it perfectly yours. Search the following pages for inspiring designs or check-out our door designer at www.masonite.com.



unique designs reflecting style



- 1 Barrington® Flagstaff™
- 2 Barrington® Mahogany Textured BR2 glass
- 3 Barrington® Craftsman Mahogany Textured Clear glass
- 4 Barrington® Flagstaff™ AvantGuard™ Spanish Cedar finish
- 5 Barrington® Oak Textured BR2 glass
- 6 Barrington® Mahogany Textured BR3 glass
- 7 Barrington® Sierra™ AvantGuard™ Black Walnut finish
- 8 Barrington® Oak Textured BR1 glass
- 9 Barrington® Sierra™ AvantGuard™ Spanish Cedar finish
- 10 Barrington® Sierra™ plank

- 11 HD Steel Monaco™ glass
- 12 HD Steel Alston™ glass
- 13 HD Steel Patio with Mini-Blinds
- 14 HD Steel Aurora™ glass
- 15 HD Steel Sienna™ glass
- 16 HD Steel Aria™ glass
- 17 HD Steel Element™ glass
- 18 HD Steel Quattro™ glass sidelites

- 19 Belleville® Mahogany Textured Naples™ glass
- 20 Belleville® Oak Textured Zavalla™ glass
- 21 Belleville® Oak Textured Navarro™ glass
- 22 Belleville® Mahogany Textured Oxford™ glass
- 23 Belleville® Oak Textured Marquise™ glass
- 24 Belleville® Smooth Madrid™ glass
- 25 Belleville® Smooth Mondrian™ glass
- 26 Belleville® Smooth Quattro™ glass



Masonite makes choosing the perfect entrance for your home as easy as...

123

Explore, design and create the entryway of your dreams with our online door designer and view our vast selection of interior doors designed to complement our entry systems at www.masonite.com.

choosing is
easy as

123

your style

1 choose your style

Choose a Masonite entry door design to suit your taste and complement your home's architectural style. Select from our vast line of traditional, contemporary or modern designs – from 1 panel to 9 panel patterns with or without decorative glass elements. Get creative and design your own custom look by enhancing your door with beautiful matching glass, transoms and sidelites.

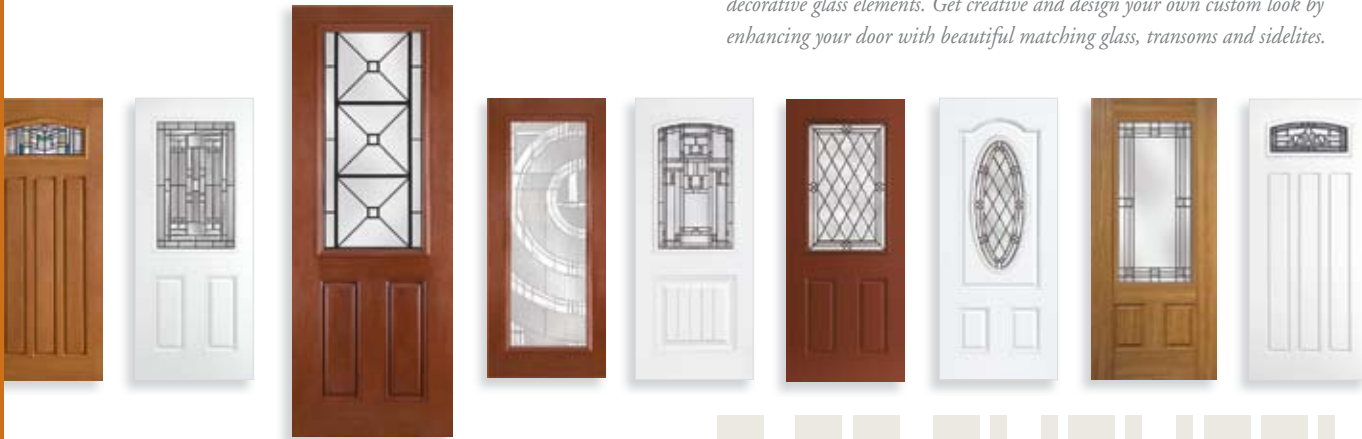

2 choose your glass

Maximize the beauty and visual impact of your new door by coordinating Masonite glass elements from our collection of exquisite designs. Decorative glass embraces natural light and transforms any entryway into a vision of beauty without compromise. So, add charm and sophistication to your home's entry, inside and out, with one of our superbly crafted glass designs offered in a variety of configurations. The choice is yours.



3 choose your door



Sample doors shown. Complete offering of available doors and glass styles displayed throughout the catalog.

Selecting the right door can bring years of enjoyment and hassle-free maintenance that will leave a lasting impression. Masonite Textured Fiberglass doors display exceptional, deep wood-grain detail, adding richness and significance to your home's exterior. Our smooth fiberglass doors are perfectly engineered for durability and longevity, plus they're easy-to-paint for a custom look. Masonite Steel doors offer security and protection for your peace of mind.

- **BAR** Barrington® Oak Textured
- **BRM** Barrington® Mahogany Textured
- **BLT** Belleville® Oak Textured
- **BMT** Belleville® Mahogany Textured
- **BLS** Belleville® Smooth
- **OAK** Oakcraft®
- **SHD** Sta-Tru® HD Steel
- **MHD** Masonite® HD Steel

Design your own entrance



www.masonite.com
Visit our website and be amazed how **easy** it is to create the entrance that will reflect your style.

explore the difference

Masonite entry doors

more door options with more door value

We bring you more styles, designs, textures and sizes to choose from for your home. Homeowners, remodelers, architects and builders rely on Masonite for superior craftsmanship, durability and value in both fiberglass and steel doors. Choose from our extensive line of entry doors to make all your entrances grand.

Masonite Fiberglass Textured doors offer the look of real wood that is easily stainable with low maintenance and extreme durability.

	BARRINGTON®			AVANTGUARD™	BELLEVILLE®		OAKCRAFT®	HD STEEL
	TRADITIONAL	CRAFTSMAN™	SIERRA® & FLAGSTAFF™	FINISHES	TEXTURED	SMOOTH	TEXTURED	STA-TRU® HD
	 Rich, classic elite line offers superior wood-grain authenticity with excellent durability and performance.	 Crafted in Mission style with your choice of our superior wood-grain texture engineered for excellent durability and performance.	 Southwest and country inspired designs in our superior wood-grain motif engineered for excellent durability and performance.	 Real wood aesthetic design composed of an authentic image layer coated with five layers of defense for the ultimate in durability.	 Mix and match high-performing natural wood-grain textured door designs with your choice of decorative glass.	 Sleek look with a variety of door and glass options to choose from, engineered for performance.	 Our economical option of traditional designs with standard oak pattern in durable fiberglass.	 High-definition panel profile offers the security of steel for years of performance.
Wood Door Authenticity	★★★★★ Exceptional	★★★★★ Exceptional	★★★★★ Exceptional	★★★★★ Exceptional	★★★★★ Excellent	★★★ Fine	★★★ Fine	★★ Good
Panel Profile	Raised moulding with elegant profile and recessed panels	Flat recessed panels with shaker style profile	Planked or non-planked panels with simple refined profiles	Planked or non-planked panels with simple refined profiles	High-definition fiberglass profile	High-definition fiberglass profile	Standard profile	High-definition steel profile
Wood Grain Texture	Traditional oak & mahogany with variable-depth wood-grain	Rift cut oak & traditional mahogany with variable-depth wood-grain	Traditional & ribbon-striped mahogany with variable-depth wood-grain	Traditional & ribbon-striped mahogany with variable-depth wood-grain	Traditional oak & ribbon-striped mahogany with variable-depth wood-grain	Ultra-smooth	Traditional oak with single-depth wood-grain	Smooth
Edge (Stile) Construction	True square-edge	True square-edge	True square-edge	True square-edge	True square-edge	True square-edge	True square-edge	Interlocking
Edge (Stile) Material	Stainable/paintable premium hardwood	Stainable/paintable premium hardwood	Stainable/paintable premium hardwood	Stainable/paintable premium hardwood	Stainable/paintable wood*	Paintable wood	Stainable/paintable wood	Paintable wood or steel
Finish Options	Stain or paint	Stain or paint	AvantGuard™ pre-finished, stain or paint	AvantGuard™ pre-finished	AvantGuard™ pre-finished, stain or paint	Paint	Stain or paint	Pre-finished white or paint
Durability & Performance	Lifetime warranty [†]	Lifetime warranty [†]	Lifetime warranty [†]	Lifetime warranty [†] (5 year on finish)	Lifetime warranty [†]	Lifetime warranty [†]	25 year warranty [†]	5-20 years [†]
Composite Bottom Rail	✓	✓	✓	✓	✓	✓	✓	✓
Rust Proof	✓	✓	✓	✓	✓	✓	✓	✓
Dent Proof	✓	✓	✓	✓	✓	✓	✓	✓
ENERGY STAR*	✓	✓	✓	✓	✓	✓	✓	✓
Glass Options	Custom	Custom	Custom	Custom	Standard	Standard	Standard	Standard
Glass Designs	4	3	4 (sidelites only)	5+	21+	21+	21+	21+
Glazing Assembly	Custom factory-glazed (installed)	Custom factory-glazed (installed)	Custom factory-glazed (installed)	Custom factory-glazed (installed)	Traditional glazing inserts	Traditional glazing inserts	Traditional glazing inserts	Traditional glazing inserts



Masonite Patio

Masonite has an extensive line of entry door products and accessories for your home including patio units, flush-glazed doors, steel frames, internal mini-blinds, stain kits and more.



*A critical component of an ENERGY STAR qualified entryway.
 *Belleville Mahogany has premium hardwood stiles.
 †All warranties are limited.

Barrington® essence of Luxury & performance

Barrington® Traditional & Timeless Door Styles

Timeless designs complement most any décor and offer long-lasting performance.

THE BEAUTY OF A GENUINE HARDWOOD DOOR

- 1 Authentic Wood-Grain Texture**
 - ✓ composite door surface replicates an authentic mahogany or oak door appearance
 - ✓ features Masonite's variable depth, realistic, wood-grain texture
 - ✓ finishes easily and beautifully
- 2 Distinct Raised Moulding**
 - ✓ raised moulding creates beautiful shadow lines
 - ✓ panels are recessed below the surface at the stiles & rails
 - ✓ adds visual depth and character
- 3 Oversized Lock Block**
 - ✓ lock area is reinforced to accommodate premium door hardware
- 4 Stain-Grade Matching Hardwood Stiles**
 - ✓ built with True Square-Edge construction
 - ✓ engineered oak or mahogany capped stiles

ARCHITECTURALLY CORRECT DESIGN WITH CUSTOM GLAZING

- 5 Glass Frame Profiles**
 - ✓ designed to match the panel moulding for a consistent appearance
- 6 Raised Moulding Profile**
 - ✓ aligns vertically on door surface with glass frame
 - ✓ replicates authentic wood door construction
- 7 Factory-Glazed Doors & Sidelites**
 - ✓ yields wider glass and narrower stiles & rails without unsightly screw plugs



BARRINGTON® OAK TEXTURED with BR3 glass BAR-411-BR3-3

Barrington® BR1 brass caming



elegance...

exquisite wood-grain texture

Masonite Fiberglass Doors are Engineered to Last a Lifetime

- proprietary, high-performance fiberglass doors are specially engineered to provide maximum protection and durability
- will not dent or rust, plus resists splitting, cracking and warping
- square-edge, engineered stiles provide excellent dimensional stability for harsh weather climates
- reinforced lock block provides strength and security for door hardware
- high-quality composite wood bottom rails are rot and corrosion resistant
- backed by a Limited Lifetime Warranty



- BAR Barrington® Oak Textured
- BRM Barrington® Mahogany Textured



BRM Barrington® Mahogany Textured

BAR Barrington® Oak Textured

BARRINGTON® BR1 glass brass caming

antique black

Barrington® BR2 antique black caming



platinum

Barrington® BR3 platinum caming

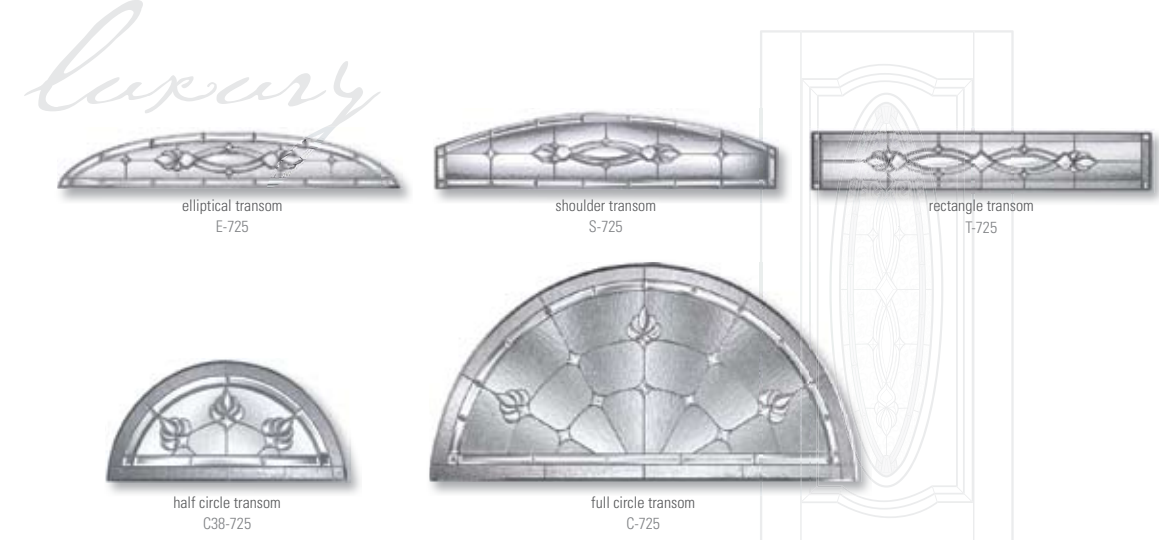
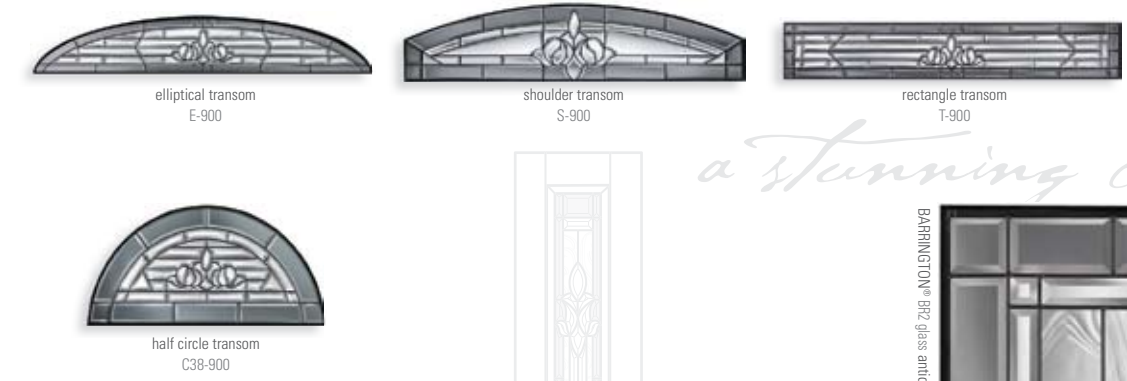

a stunning collection

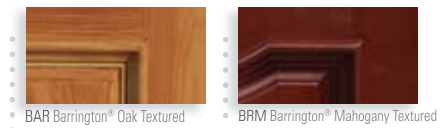

BAR Barrington® Oak Textured

BRM Barrington® Mahogany Textured

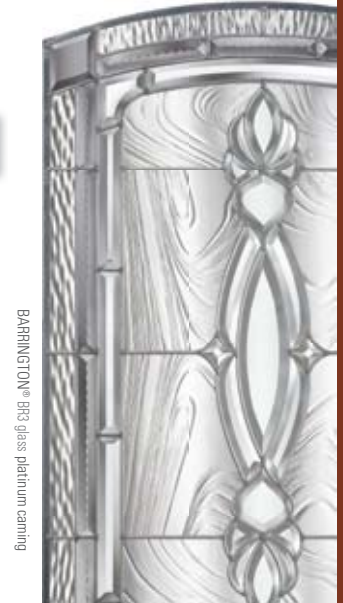

inspired by people

Barrington® CB1 clear beveled

clear beveled

6'8" DOORS



2 panel 3/4 oval lite oak
BAR-303-CB1-2V
2 panel 3/4 oval lite mahogany
BRM-303-CB1-2V
2 panel 3/4 rectangle lite oak
BAR-405-CB1-2
3 panel 1/2 camber-top lite oak
BAR-411-CB1-3

6'8" SIDELITES



1 panel 3/4 lite oak
BARSL-451-CB1-1
1 panel 3/4 lite mahogany
BRMSL-451-CB1-1

Our traditionally styled Barrington Fiberglass doors are now available with a wide clear bevel in a select number of designs. The large 1-1/4" wide bevel is placed in the middle of a triple-pane configuration to maximize the opulent appearance of the bevel and improve the energy efficiency of the door. This beautiful combination of authentic wood door appearance along with this simple elegant glass design will provide the historic appearance your entryway demands.

- BAR Barrington® Oak Textured
- BRM Barrington® Mahogany Textured

Clear transoms also available

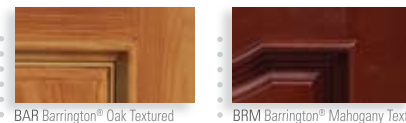

• BAR Barrington® Oak Textured
• BRM Barrington® Mahogany Textured

BARRINGTON® OAK TEXTURED with CB1 glass BAR-303-CB1-2V

BARRINGTON® CB1 glass clear beveled

BARRINGTON® MAHOGANY TEXTURED with CB1 glass BRM-303-CB1-2V

BARRINGTON® OAK TEXTURED with CB1 glass - door BAR-405-CB1-1 - sidelites BARSL-451-CB1-2

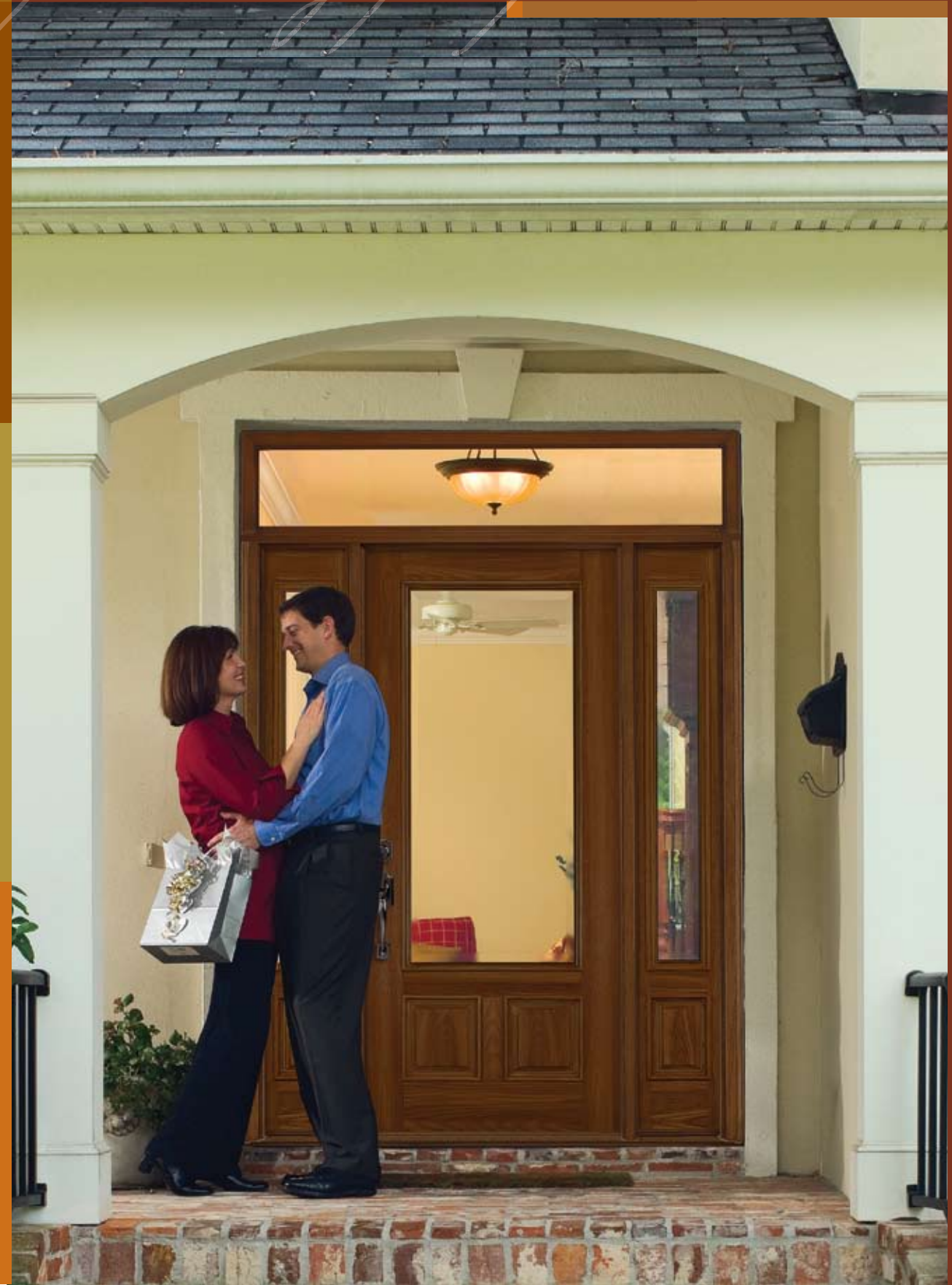

Craftsman

architecturally inspired

Barrington® Craftsman

3 Glass Designs

Barrington® Craftsman Mission Styled Doors

Our Arts & Crafts/Mission style doors bring the beauty of hand-crafted premium rift-cut oak or old-growth mahogany with the durability and ease of our low maintenance premium fiberglass.

UNMATCHED CRAFTSMANSHIP FOR AN AUTHENTIC WOOD LOOK

1 Authentic Wood-Grain Texture

- ✓ composite door surface replicates an authentic mahogany or oak door appearance
- ✓ features Masonite's variable depth, wood-grain texture
- ✓ finishes easily and beautifully

2 Oversized Lock Block

- ✓ lock area is reinforced to accommodate premium door hardware

3 Stain-Grade Matching Hardwood Stiles

- ✓ assembled with True Square-Edge construction

4 Recessed Flat Panels

- ✓ Shaker sticking and recessed flat panels replicate a true Mission design
- ✓ adds visual depth and character

ARCHITECTURALLY CORRECT DESIGN WITH CUSTOM GLAZING

5 Profile Alignment

- ✓ recessed panels align perfectly with glass placement

6 Custom Glazing

- ✓ glass is integrated into door design — creating a simple, clean Mission style

7 Optional Dentil Shelves & SDL Lite Kits

- ✓ customize the door style with dentil shelving or simulated divided lite kits



BARRINGTON® CRAFTSMAN OAK TEXTURED with applied dentil shelf and SDL kit BRC-225-BS1-3

6'-8" DOORS



3 panel oak BC4 glass BRC-225-BC4-3
3 panel mahogany BC4 glass BCM-225-BC4-3
3 panel oak BC5 glass BRC-225-BC5-3
3 panel mahogany BC5 glass BCM-225-BC5-3
3 panel oak clear* glass BRC-225-BS1-3
3 panel mahogany clear* glass BCM-225-BS1-3

6'-8" SIDELITES



1 panel oak BC4 glass BRCSL-609-BC4-1
1 panel mahogany BC4 glass BCM-609-BC4-1
1 panel oak BC5 glass BRCSL-609-BC5-1
1 panel mahogany BC5 glass BCM-609-BC5-1
1 panel oak clear* glass BRCSL-609-BS1-1
1 panel mahogany clear* glass BCM-609-BS1-1



BRC Barrington® Craftsman Oak
BCM Barrington® Craftsman Mahogany

simple & clean

BC4 antique black

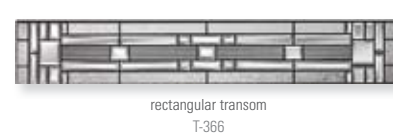

BC5 antique black

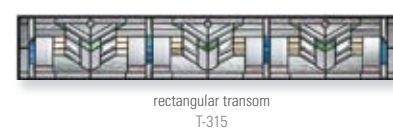
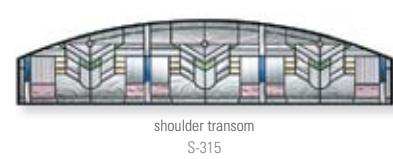

Masonite Fiberglass Doors are Engineered to Last a Lifetime

- proprietary, high-performance fiberglass doors are specially engineered to provide maximum protection and durability
- will not dent or rust, plus resists splitting, cracking and warping
- square-edge, engineered stiles provide excellent dimensional stability for harsh weather climates
- reinforced lock block provides strength and security for door hardware
- high-quality composite wood bottom rails are rot and corrosion resistant
- backed by a Limited Lifetime Warranty



Clear transoms also available

*Upgrade BS1 clear glass to Low-E and Argon filled (LEA) to increase thermal performance and savings.

BARRINGTON® CRAFTSMAN OAK TEXTURED BC4 glass



Sierra™ & Flagstaff™

cottage&rustic

MASONITE® FIBERGLASS BARRINGTON® DOOR COLLECTION

MASONITE® FIBERGLASS BARRINGTON® DOOR COLLECTION



BARRINGTON® SIERRA™ 2 panel camber-top plank BSP-2

BARRINGTON® FLAGSTAFF™ plank BFS-P

Barrington® Sierra™ & Flagstaff™



Barrington® Sierra™ & Flagstaff™ Southwestern Inspired Designs

Barrington® Sierra™

Designed with a rustic flair, the Sierra Series incorporates gentle arches and beautiful old-growth mahogany texture that finishes easily.

Barrington® Flagstaff™

Features our ribbon-stripped mahogany texture and soft planking lines to create a more contemporary look that finishes easily.

Masonite Fiberglass Doors are Engineered to Last a Lifetime

- proprietary, high-performance fiberglass doors are specially engineered to provide maximum protection and durability
- will not dent or rust, plus resists splitting, cracking and warping
- square-edge, engineered stiles provide excellent dimensional stability for harsh weather climates
- reinforced lock block provides strength and security for door hardware
- high-quality composite wood bottom rails are rot and corrosion resistant
- backed by a Limited Lifetime Warranty



1 Mahogany Texture

✓ beige-colored fiberglass facing with beautiful Masonite mahogany texture

2 Oversized Lock Block

✓ lock area is reinforced to accommodate premium door hardware

3 Stain-Grade Matching Mahogany Stiles

✓ finished with True Square-Edge construction

4 Factory-Glazed Sidelites

✓ matching full sidelites are factory-glazed, removing unsightly screw plugs

ARCHITECTURALLY CORRECT DESIGN WITH CUSTOM GLAZING



BARRINGTON® SIERRA™ 2 panel camber-top plank BSP-2

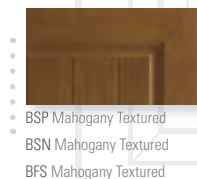

- BSP Barrington® Sierra™ Plank
- BSN Barrington® Sierra™ No Plank
- BFS Barrington® Flagstaff™

*Upgrade BS1 clear glass to Low-E and Argon filled (LEA) to increase thermal performance and savings.

Masonite® AvantGuard™ finish

a work of art

AvantGuard™ The Ideal Fusion of Wood & Fiberglass

Some would call a beautiful wood door with little to no maintenance a dream. We call it AvantGuard™. Unlike any other door, AvantGuard™ perfectly blends beauty and durability into one patented package by combining the aesthetics of wood with the durability of fiberglass.

1 Authentic Graining

- ✓ what makes AvantGuard superior is its appearance. Rather than simply applying stain over a textured fiberglass facing, an image layer is applied to a protective primer layer. This image is an authentic reproduction of the original master
- ✓ available in your choice of Spanish Cedar or Black Walnut finish

2 Ultimate Durability: Five Layers of Defense

- ✓ **automotive clear coat:** protects the door from UV rays and normal wear and tear
- ✓ **image layer:** UV stable image layer provides real wood aesthetic
- ✓ **protective base coat:** provides stability and adhesion between the image layer and the low-maintenance fiberglass facing
- ✓ **textured fiberglass:** Masonite's exclusive formula of fiberglass is more stable when subjected to temperature swings
- ✓ **polyurethane foam:** insulates your home and adheres the door components together

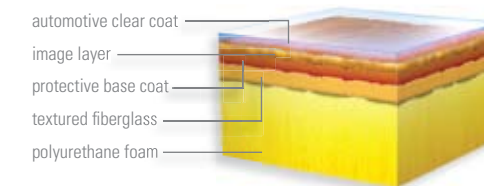

Note: Above diagram not to scale

3 Unprecedented 5 Year Finish Warranty*

- ✓ does not require top coating in the middle of the warranty period
- ✓ covers up to the full purchase price
- ✓ see Masonite.com for full warranty details. Barrington® Sierra™, Barrington® Flagstaff™ and Belleville® Hollister™ door panels are covered by a Limited Lifetime Warranty



BARRINGTON® SIERRA™ with AvantGuard™ Spanish Cedar finish BAC-2

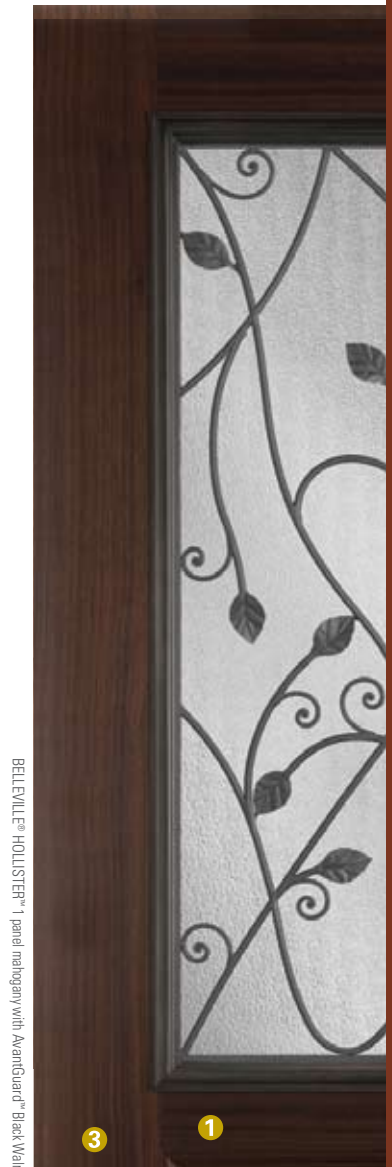

BELLEVILLE® HOLLISTER™ 1 panel mahogany with AvantGuard™ Black Walnut finish BW-4048171

DOOR FINISH			
Criteria	Stained* Wood	AvantGuard™	Stained* Fiberglass
Appearance Authenticity	High	High	Medium
Top Coating Required	Yearly	After 5 Years	After 2-3 Years
Finish Warranty	1 Year	5 Year	2+ Years
ENERGY STAR Eligible**	No	Yes	Yes
Weatherability	Low	High	Medium

*Stained finish refers to a conventional stain and topcoat system. Finish warranty may vary by product supplier.
**See page 94 for more details.

authentic graining



These photos of a production door showcase the color spectrum and depth capabilities of the AvantGuard™ process. Custom finished hardwood stiles provide the final touches.

What makes AvantGuard™ superior is its appearance. Rather than simply spreading stain over a textured fiberglass facing, an image layer is applied to a protective primer layer.

3
1
2

spanish cedar

- BAC Barrington® AvantGuard™ Spanish Cedar
- BAW Barrington® AvantGuard™ Black Walnut



BARRINGTON® SIERRA™ with AvantGuard™ Spanish Cedar finish door BAC-2 – sidelites BACSL-154-BR2



BARRINGTON® FLAGSTAFF™ with AvantGuard™ Black Walnut finish BAW-P



BELLEVILLE® HOLLISTER™ with AvantGuard™ Black Walnut finish and Sienna™ glass BLW-404-817-1



Belleville® Textured

shaping grand entryways

BELLEVILLE®
Fiberglass Entry Doors

elegance & Durability



BELLEVILLE® HOLLISTER™ MAHOGANY TEXTURED with Alison™ glass – door BMT-404-388-1 – sidelites BMTSL-450-388-1

BELLEVILLE® MAHOGANY TEXTURED with Rockland™ glass BMT-105-556-2



Belleville® Textured – Super Wood Door Beauty

A great combination of real wood door appearance with the long-lasting performance of our superior fiberglass.

authentic

1 Real Wood Appearance

- ✓ premium variable-depth oak or ribbon-stripped mahogany grain textures create the look of natural wood
- ✓ finishes easily and beautifully

2 High-Definition Profile Panels

- ✓ adds architectural interest and elegance

3 Large Reinforced Lock Block

- ✓ provides added strength and security for door hardware

4 True Square-Edge Construction

- ✓ creates the most authentic wood door appearance

5 Stain-Grade Matching Mahogany Stiles

- ✓ a premium feature on our Belleville Mahogany line



6'8" DOORS

6'8" DOORS

8'0" DOORS

- | | | | | | | | |
|----------------------|---------------------------|-----------------------------------|---------------------------------|---|---|---------------------------------------|---------------------------|
| flush oak
BLT-X | 1 panel arch oak
BLT-1 | 2 panel square-top oak
BLT-2S | 3 panel arch-top oak
BLT-3 | 4 panel blank-top oak
BLT-4BT | 4 panel New England oak
BLT-4NE | 6 panel blank-top oak
BLT-6BT | |
| 6 panel oak
BLT-6 | 6 panel mahogany
BMT-6 | 6 panel camber-top oak
BLT-6CT | 8 panel parliament oak
BLT-8 | Hollister™
2 panel mahogany
BMT-2 | 2 panel universal oak
BLTSL-2 | 2 panel universal mahogany
BMTSL-2 | flush mahogany
BMTSL-X |
| flush oak
BLT-X | 2 panel oak
BLT-2S | 6 panel oak
BLT-6 | 6 panel mahogany
BMT-6 | 8 panel parliament oak
BLT-8 | Hollister™
2 panel mahogany
BMT-2 | 2 panel universal oak
BLTSL-2 | flush mahogany
BMTSL-X |

Masonite Fiberglass Doors are Engineered to Last a Lifetime

- proprietary, high-performance fiberglass doors are specially engineered to provide maximum protection and durability
- will not dent or rust, plus resists splitting, cracking and warping
- square-edge, engineered stiles provide excellent dimensional stability for harsh weather climates
- reinforced lock block provides strength and security for door hardware
- high-quality composite wood bottom rails are rot and corrosion resistant
- backed by a Limited Lifetime Warranty



Belleville® Smooth *great looks* design & flexibility

BELLEVILLE®
Fiberglass Entry Doors



BELLEVILLE® SMOOTH with Panama™ glass doors BLS-304-725-3 – sidelites BLS-450-725-1 – transom E-725

BELLEVILLE® SMOOTH with Zavalla™ glass BLS-404-537-2

Belleville® Smooth – High-Performance Fiberglass

Designed with high-definition profiles that capture the beauty and elegance of a wood door with the low-maintenance of fiberglass.

1 High-Performance Smooth Surface

- ✓ ideal for painting and will not rust or dent

2 High-Definition Panel Profile

- ✓ adds architectural interest and elegance

3 Reinforced Lock Block

- ✓ provides added strength and security for door hardware

4 True Square-Edge Construction

- ✓ provides an authentic wood door appearance

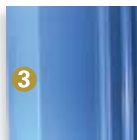

Masonite Fiberglass Doors are Engineered to Last a Lifetime

- proprietary, high-performance fiberglass doors are specially engineered to provide maximum protection and durability
- will not dent or rust, plus resists splitting, cracking and warping
- square-edge, engineered stiles provide excellent dimensional stability for harsh weather climates
- reinforced lock block provides strength and security for door hardware
- high-quality composite wood bottom rails are rot and corrosion resistant
- backed by a Limited Lifetime Warranty



6'8" DOORS

6'8" DOORS

8'0" DOORS

BELLEVILLE® SMOOTH with Aurora™ glass BLS-122-207-X

BELLEVILLE® SMOOTH with Aria™ BLS-106-455-3

smooth hardwood door beauty

Oakcraft®

the look of natural wood

OAKCRAFT® with Element™ glass – door OAK-404-329-2 – sidelites OAK-450-328-1



Oakcraft® Doors – Adding Richness

Experience the beauty of genuine oak without the maintenance.

Our Oakcraft line of doors feature a standard oak texture and panel profile that provide a low maintenance, economical option that is backed with a limited 25 year warranty.

AS WITH ALL MASONITE FIBERGLASS DOORS, OAKCRAFT DOORS INCLUDE THESE STANDARD FEATURES:

- 1 High-Performance Fiberglass**
 - ✓ proprietary door facings are specially engineered to provide maximum protection and durability
 - ✓ adds architectural appeal and elegance
- 2 Square-Edge Construction**
 - ✓ provides an authentic wood door appearance
- 3 Reinforced Lock Block**
 - ✓ provides strength and security for door hardware
- 4 Rot-Resistant Bottom Rails**
 - ✓ high-quality composite wood bottom rails are rot and corrosion resistant



wood-grain texture

Oakcraft®
Wood-grain Textured
FIBERGLASS ENTRY DOORS

incredible warmth

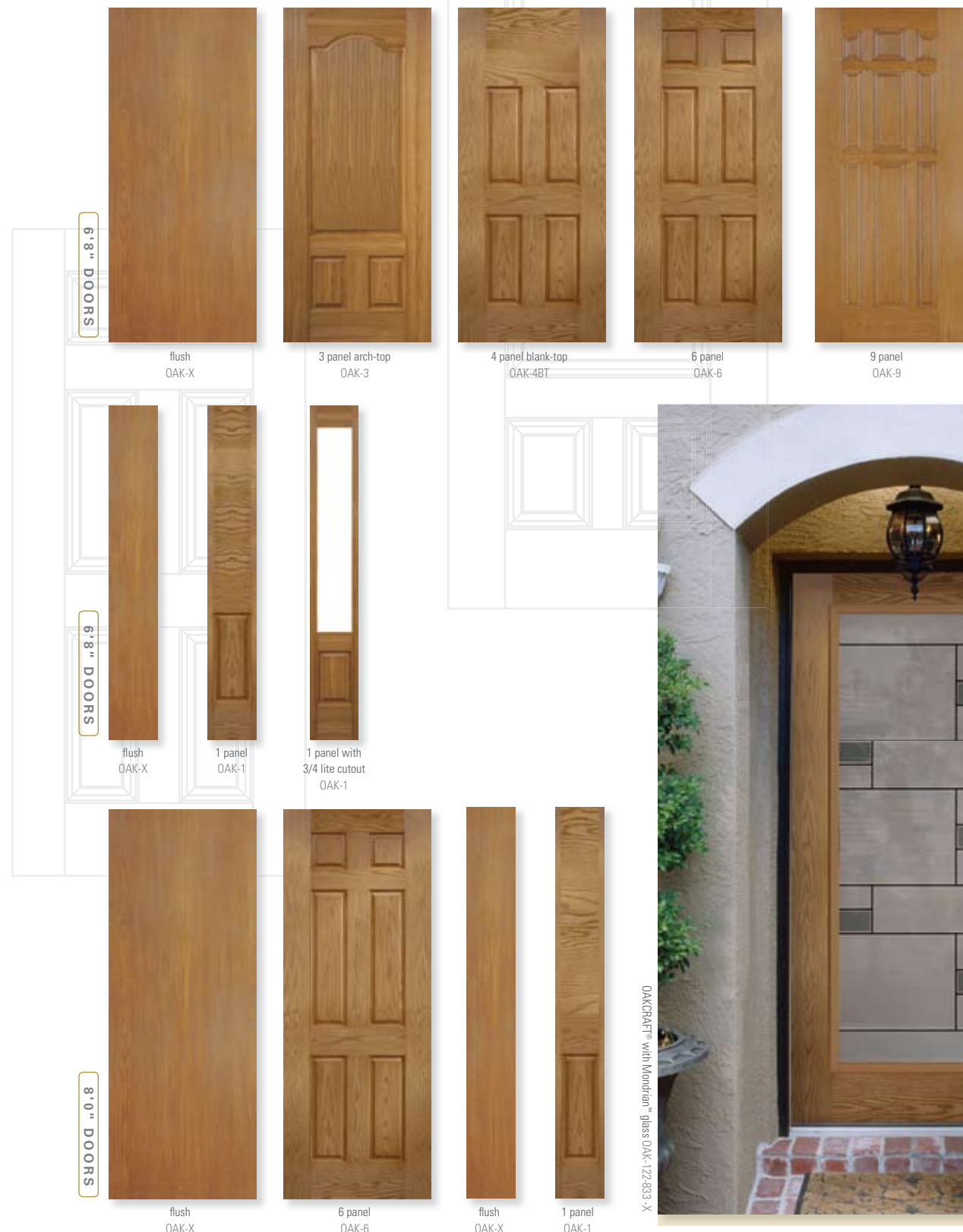

OAKCRAFT® with Mondrian™ glass OAK-122-833-X



easy finishing

OAKCRAFT® with Woodridge™ glass OAK-304-443-3

Steel

entry doors

The Ultimate Steel Door Collection

Masonite Steel doors feature high-definition decorative panel profiles that closely replicate the appearance of a high-end wood door with the ultimate in security. They truly make a statement with the addition of Specialty™ Glass inserts for a grand entrance.

Standard features for steel-edge & wood-edge

- High-Definition Panel Profile**
 - ✓ creates excellent shadow lines and distinct panel designs
- Internal Blocking**
 - ✓ lock area is reinforced with a lock block to provide solid mounting surface
- Two Finish Options**
 - ✓ Masonite® HD features a baked-on primer for a more durable finish
 - ✓ Sta-Tru® HD has a prefinished white surface (no initial finishing required on door panel)
- Rot-Resistant Bottom Rail**
 - ✓ high-performance composite material is utilized on all bottom rails

MASONITE® HD STEEL with Quattro™ glass – door MHD-2S – sidelites MHDLSL-152-957-X

Steel-Edge features



- Interlocking Steel-Edge**
 - ✓ has six 90° steel bends in each edge to ensure stability and resist warping
- Square-Edge Design**
 - ✓ wood door appearance
- Vinyl Extrusion**
 - ✓ locks facings together and provides an insulated thermal barrier
- Steel Reinforcements**
 - ✓ hinges are flush mounted into steel reinforcements to help prevent hinge sag

✓ 90-minute fire label available (opaque doors only)

Wood-Edge features



- Engineered Construction**
 - ✓ finger-jointed hinge stile
 - ✓ LVL lock stile
- Interlocking Design**
 - ✓ grooved stiles add strength and structural rigidity
 - ✓ steel facings wrap over stiles with a "J" bend

✓ 20-minute fire label available (opaque doors only)

STA-TRU® HD LIMITED 20 YEAR WARRANTY
 MASONITE® HD LIMITED 5 YEAR WARRANTY
 MASONITE® UTILITY LIMITED 1 YEAR WARRANTY

Sta-Tru® HD
 PREFINISHED STEEL ENTRY DOORS

Masonite® HD
 HIGH-DEFINITION STEEL ENTRY DOORS

Masonite®
 UTILITY STEEL DOORS

Sta-Tru and Masonite High-Definition Steel Designs



Masonite Utility Steel Designs

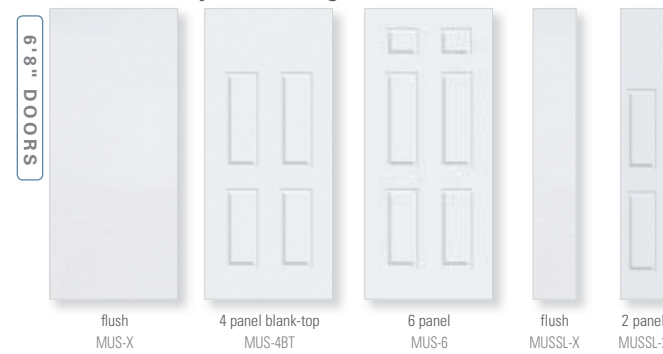

Decorative

- SHD Sta-Tru® High-Definition Prefinished Steel
- MHD Masonite® High-Definition Steel
- MUS Masonite® Utility Steel





your style
glass

transforming
light into
brilliance

Decorative glass embraces natural light and transforms any entryway into a vision of beauty without compromise. So, add charm and sophistication to your home's entry, inside and out, with one of our superbly crafted glass designs offered in a variety of configurations. The choice is yours.



Sienna® glass 106-817

BELLEVILLE® HOLLISTER™ MAHOGANY TEXTURED with Element™ glass BMT-404-328-1

Design your own entrance



www.masonite.com
 Visit our website and be amazed how **easy** it is to create the entrance that will reflect your style.

Please note, due to the limitations of the printing process, doors and glass shown may not match exactly in color to actual product. Masonite reserves the right to make ongoing improvements and changes to existing designs. All left and right lites and camber-tops are left and right facing as viewed from the outside.



MasoniteCodesDefined

BLT - 106 - 817 - 1

door acronym glass shape & size glass design & coming # visible door panels

Door Acronym

BLT Belleville® Oak Textured
 BMT Belleville® Mahogany Textured
 BLS Belleville® Smooth
 OAK Oakcraft®
 SHD Sta-Tru® HD Steel
 MHD Masonite® HD Steel

SL = sidelite

BLTSL-450-817-1

2236 = glass dimensions 22" x 36"

GlassLiteSize&Shape

Rectangle Lite	S-Top Lite	Camber-Top Lite	Round-Top Lite	Oval Lite	Fan Lite	Camber-Top Fan Lite
105 22" x 36"	Round-Top	137 22" x 10"	Camber-Top Fan	300 20" x 57"	Oval	
106 22" x 36"	Rectangle	149 8" x 64"	Round-Top	304 16" x 40"	Oval	
107 22" x 37"	Camber-Top	151 8" x 64"	Rectangle	306 14" x 54"	Oval	
120 20" x 64"	Rectangle	152 7" x 64"	Rectangle	404 22" x 48"	Rectangle	
122 22" x 64"	Rectangle	200 8" x 36"	Round-Top	410 22" x 47"	S-Top	
129 8" x 36"	Rectangle	201 8" x 58"	Round-Top	450 8" x 48"	Rectangle	
135 22" x 10"	Fan	203 8" x 42"	Round-Top	810 22" x 80"	Rectangle	
136 7.5" x 18.5"	Rectangle	228 22" x 10"	Rectangle	852 8" x 80"	Rectangle	

Sample selection of door panels shown

#VisibleDoorPanels

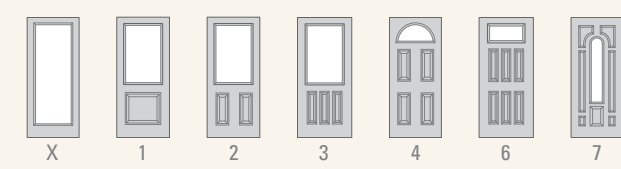

GlassDesign&Caming

Specialty decorative glass index

Glass Selections..... 36

Alston™ 338..... 44

Aria™ 455..... 46

Aurora™ 207..... 62

Element™ 328..... 38

Fundy™ 264..... 76

Georgian™ 515•517•518..... 70

Madrid™ 900..... 64

Marquise™ 777•778•779..... 60

Monaco™ 315..... 52

Mondrian™ 833..... 48

Naples™ 366..... 54

Navarro™ 793..... 42

Oxford™ 137..... 66

Panama™ 724•725..... 68

Quattro™ 957..... 58

Rockland™ 566..... 50

Sienna™ 817..... 40

Victorian™ 856..... 74

Woodbridge™ 442•727•920
 443•728•921..... 72

Zavalla™ 537..... 56

clearglass

External Grille Inserts..... 78

Internal Blinds..... 78

Internal Grille Inserts..... 79

One Lite Inserts..... 79

Venting Inserts..... 78

All Specialty sealed units are made with tempered safety glass and comply with the following:
 ANSI Z97.1-1984
 16 CFR 1201 II
 CAN/CGSB-12.1M90

Masonite® glass

MASONITE® SPECIALTY™ DECORATIVE GLASS

www.masonite.com

MASONITE® SPECIALTY™ DECORATIVE GLASS

www.masonite.com

<p><i>alston</i> GLASS</p> <p>338 ▲</p> <p>338antique black</p> <p>1 2 3 4 5 6 7 8 9</p> <p>page 44</p>	<p><i>aria</i> GLASS</p> <p>455 ▲</p> <p>455charcoal spectraweld™</p> <p>1 2 3 4 5 6 7 8 9</p> <p>page 46</p>	<p><i>aurora</i> GLASS</p> <p>207 ▲</p> <p>207platinum</p> <p>1 2 3 4 5 6 7 8 9</p> <p>page 62</p>	<p><i>mondrian</i> GLASS</p> <p>833 ▲</p> <p>833grooved charcoal spectraweld™</p> <p>1 2 3 4 5 6 7 8 9</p> <p>page 48</p>	<p><i>naples</i> GLASS</p> <p>386 ▲</p> <p>386antique black</p> <p>1 2 3 4 5 6 7 8 9</p> <p>page 54</p>	<p><i>navarro</i> GLASS</p> <p>793 ▲</p> <p>793antique black</p> <p>1 2 3 4 5 6 7 8 9</p> <p>page 42</p>	<p><i>oxford</i> GLASS</p> <p>137 ▲</p> <p>137v-groove</p> <p>1 2 3 4 5 6 7 8 9</p> <p>page 66</p>
<p><i>element</i> GLASS</p> <p>328 ▲</p> <p>328antique black</p> <p>1 2 3 4 5 6 7 8 9</p> <p>page 38</p>	<p><i>fandy</i> GLASS</p> <p>264 ▲</p> <p>264etched</p> <p>1 2 3 4 5 6 7 8 9</p> <p>page 76</p>	<p><i>georgian</i> GLASS</p> <p>515 ▲</p> <p>515brass 517platinum 518antique black</p> <p>517 ▲</p> <p>518 ▲</p> <p>1 2 3 4 5 6 7 8 9</p> <p>page 70</p>	<p><i>panama</i> GLASS</p> <p>724 ▲</p> <p>725 ▲</p> <p>724brass 725platinum</p> <p>1 2 3 4 5 6 7 8 9</p> <p>page 68</p>	<p><i>quattro</i> GLASS</p> <p>957 ▲</p> <p>957wrought iron</p> <p>1 2 3 4 5 6 7 8 9</p> <p>page 58</p>	<p><i>rockland</i> GLASS</p> <p>566 ▲</p> <p>566antique black</p> <p>1 2 3 4 5 6 7 8 9</p> <p>page 50</p>	<p><i>sienna</i> GLASS</p> <p>817 ▲</p> <p>817wrought iron</p> <p>1 2 3 4 5 6 7 8 9</p> <p>page 40</p>
<p><i>madrid</i> GLASS</p> <p>900 ▲</p> <p>900antique black</p> <p>1 2 3 4 5 6 7 8 9</p> <p>page 64</p>	<p><i>marquise</i> GLASS</p> <p>777 ▲</p> <p>778 ▲</p> <p>779 ▲</p> <p>777brass 778platinum 779antique black</p> <p>1 2 3 4 5 6 7 8 9</p> <p>page 60</p>	<p><i>monaco</i> GLASS</p> <p>315 ▲</p> <p>315antique black</p> <p>1 2 3 4 5 6 7 8 9</p> <p>page 52</p>	<p><i>victorian</i> GLASS</p> <p>856 ▲</p> <p>856antique black</p> <p>1 2 3 4 5 6 7 8 9</p> <p>page 74</p>	<p><i>woodbridge</i> GLASS</p> <p>442 ▲</p> <p>443 ▲</p> <p>444 ▲</p> <p>445 ▲</p> <p>442 * 727 * 920brass 443 * 728 * 921platinum</p> <p>1 2 3 4 5 6 7 8 9</p> <p>page 72</p>	<p><i>zaralla</i> GLASS</p> <p>537 ▲</p> <p>537platinum</p> <p>1 2 3 4 5 6 7 8 9</p> <p>page 56</p>	

Least Obscure PRIVACY RATING Most Obscure
1 2 3 4 5 6 7 8 9

MORE OPTIONS MORE DESIGNS MORE VALUE



OAKCRAFT® with Element™ glass -- door OAK-404-328-2 -- sidelite OAKSL-450-328-1

granite beveled glass
granite glass
clear beveled glass
antique black caming

Least Obscure **PRIVACY RATING** Most Obscure
1 2 3 4 5 6 7 8 9

- BLT Belleville® Oak Textured
- BMT Belleville® Mahogany Textured
- BLS Belleville® Smooth
- OAK Oakcraft®
- SHD Sta-Tru® HD Steel
- MHD Masonite® HD Steel

antique black
328caming

T-328
S-328

compatible
door unit sizes:
1'0" - 3'0" - 1'0"
1'2" - 2'8" - 1'2"
1'2" - 3'0" - 1'2"

Element™ 328 antique black

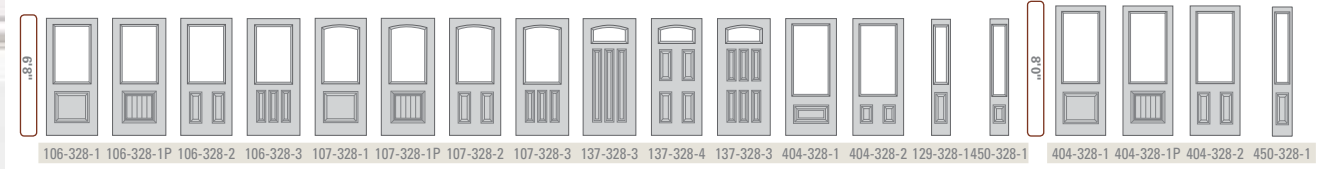

All color images of doors represent 6'8" configurations. See line art chart for 8'0" door configurations. For specific door availability, please refer to charts on pages 104-106.

element
..... GLASS

S-328 transom
T-328 transom

BLS MHD
BLS-107-328-1P
2237 camber-top

BLT BLS
BLS-106-328-3
2236

BLT BLS SHD MHD
BLT-106-328-1
2236

BLS MHD
MHD-106-328-1P
2236

BLT BMT BLS OAK SHD MHD
BMT-106-328-2
2236

BLT BLS
BLT-137-328-3
2210 camber-top

SHD MHD
SHD-107-328-1
2237 camber-top

BLT BLS OAK SHD MHD
BLT-107-328-2
2237 camber-top

BLT BLS
BLS-107-328-3
2237 camber-top

BLT BLS OAK SHD MHD
BLT-137-328-4
2210 camber-top

BLT BLS
BLT-137-328-6
2210 camber-top

BLT BLS OAK SHD MHD
BLS-404-328-2
2248

BLT BMT BLS OAK SHD MHD
BLTSL-129-328-1
836

BLT BMT BLS OAK SHD MHD
BMTSL-450-328-1
848

BMT
BMT-404-328-1
2248













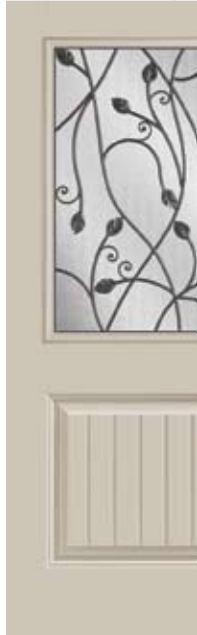

sophisticated style



tempered oceana glass
(faces inside house)
wrought iron

sienna
.....GLASS

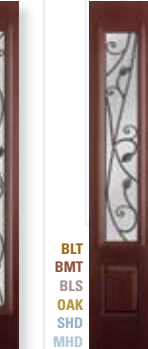
Least Obscure **PRIVACY RATING** Most Obscure
1 2 3 4 5 6 7 **8** 9

BLT BLS SHD MHD	 BLT-106-817-1 2236	BLT BMT BLS OAK SHD MHD	 BMT-106-817-2 2236	BLT BLS	 BLS-106-817-3 2236	SHD MHD	 SHD-107-817-1 2237 camber-top	 BLS-106-817-1P 2236	
BLS MHD	 MHD-107-817-1P 2237 camber-top	BLT BLS OAK SHD MHD	 BLT-107-817-2 2237 camber-top	BLT BLS	 BLS-107-817-3 2237 camber-top	BLT BMT BLS OAK SHD MHD	 BMT-122-817-X 2264	 Belleville® OAK TEXTURED with Sienna™ glass BLT-107-817-3	
BMT	 BMT-404-817-1 2248	BLT BLS OAK SHD MHD	 BLS-404-817-2 2248	BLT BLS OAK SHD MHD	 BLTSL-129-817-1 836	BLT BMT BLS OAK SHD MHD	 BMTSL-152-817-X 764	BLT BMT BLS OAK SHD MHD	 BMTSL-450-817-1 848

HD STEEL with Sienna™ glass -- door MHD-404-817-2

Sienna™ 817 wrought iron

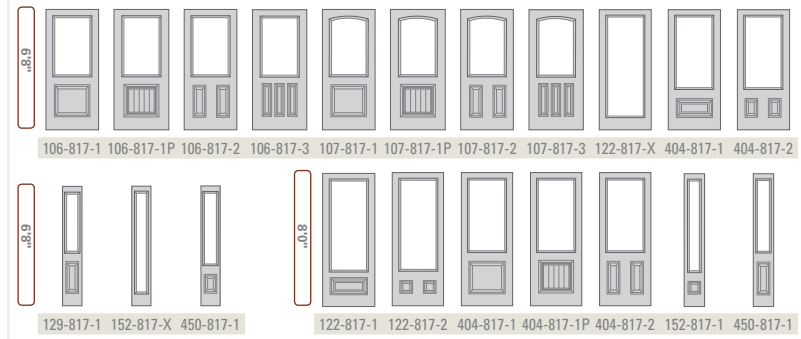

All color images of doors represent 6'8" configurations. See line art chart for 8'0" door configurations. For specific door availability, please refer to charts on pages 104-106.



- BLT** Belleville® Oak Textured
- BMT** Belleville® Mahogany Textured
- BLS** Belleville® Smooth
- OAK** Oakcraft®
- SHD** Sta-Tru® HD Steel
- MHD** Masonite® HD Steel

inspired by nature

Belleville® MAHOGANY TEXTURED with Sienna™ glass BMTSL-450-817-1

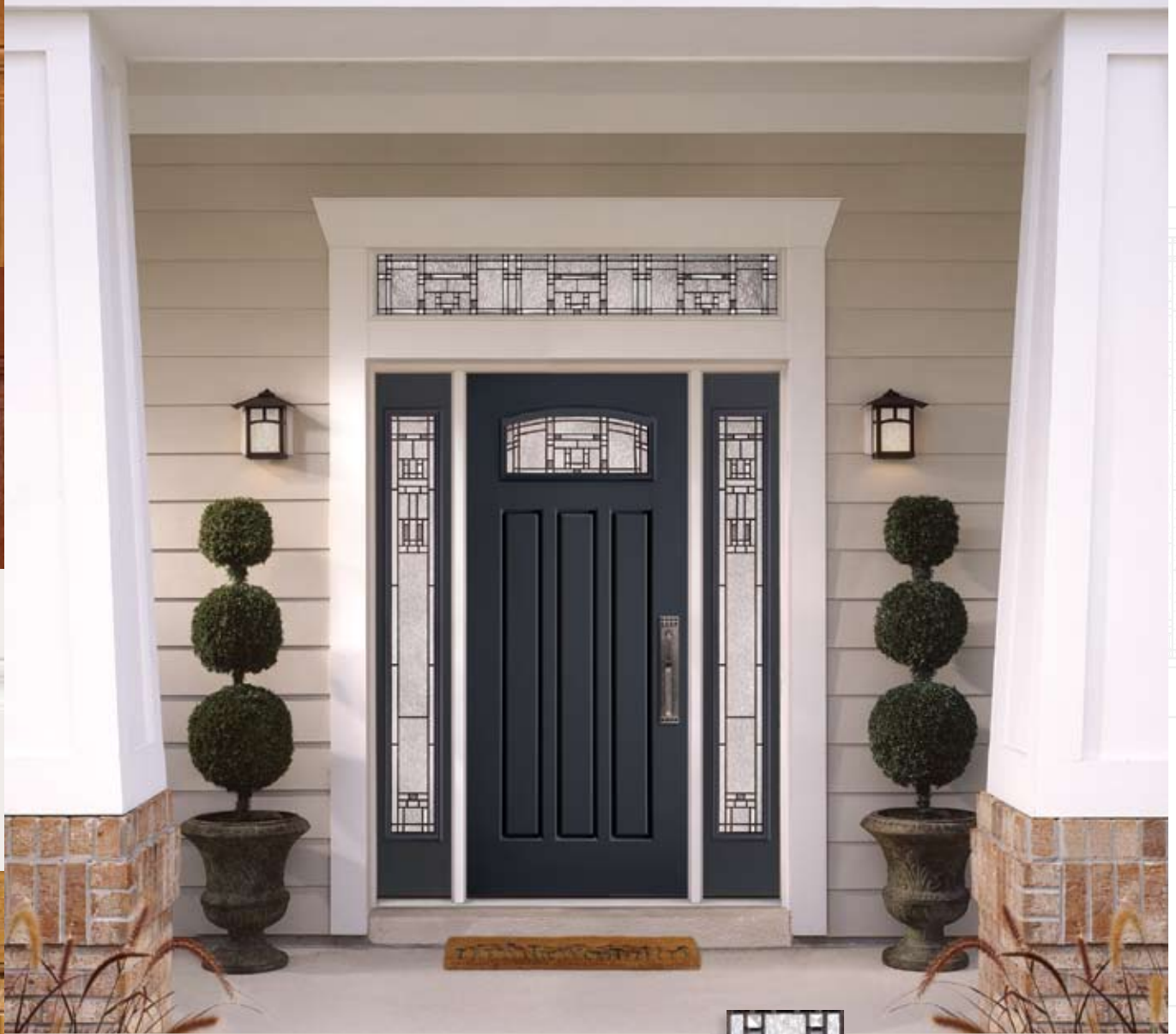

navarro
GLASS

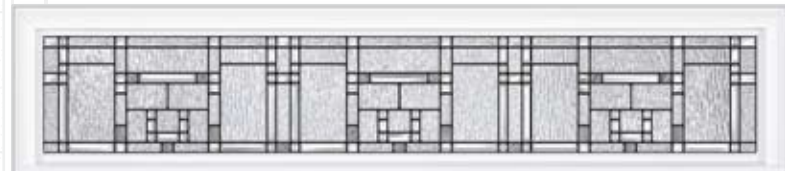

T-793 transom

BLT BLS SHD MHD	BLS MHD	BLT BMT BLS OAK SHD MHD	BLS	SHD MHD	
BLS-106-793-1 2236	MHD-106-793-1P 2236	BMT-106-793-2 2236	BLS-106-793-3 2236	SHD-107-793-1 2237 camber-top	
					BELLEVILLE® SMOOTH with Navarro™ glass BLS-228-793-6
BLS MHD	BLT BLS OAK SHD MHD	BLT BLS	BLT BLS	BLT BLS OAK SHD MHD	
MHD-107-793-1P 2237 camber-top	BLS-107-793-2 2237 camber-top	BLS-107-793-3 2237 camber-top	BLS-137-793-3 2210 camber-top	BLS-137-793-4 2210 camber-top	
BLT BLS	BLT BLS OAK	BLT BLS OAK	BLT BLS	BMT	
BLS-137-793-6 2210 camber-top	BLS-228-793-3 2210	BLS-228-793-4 2210	BLS-228-793-6 2210	BMT-404-793-1 2248	
BLT BLS OAK SHD MHD	BLT BMT BLS OAK SHD MHD	BLT BMT BLS OAK SHD MHD	BLT BMT BLS OAK SHD MHD		
BLS-404-793-2 2248	BLS-129-793-1 836	BLS-152-793-X 764	BMT-450-793-1 848		

BELLEVILLE® SMOOTH with Navarro™ glass — door BLS-137-793-3 — sidelite BLSSL-152-793-X — transom T-793



antique black
793caming

- BLT Belleville® Oak Textured
- BMT Belleville® Mahogany Textured
- BLS Belleville® Smooth
- OAK Oakcraft®
- SHD Sta-Tru® HD Steel
- MHD Masonite® HD Steel



Navarro™ 793antique black

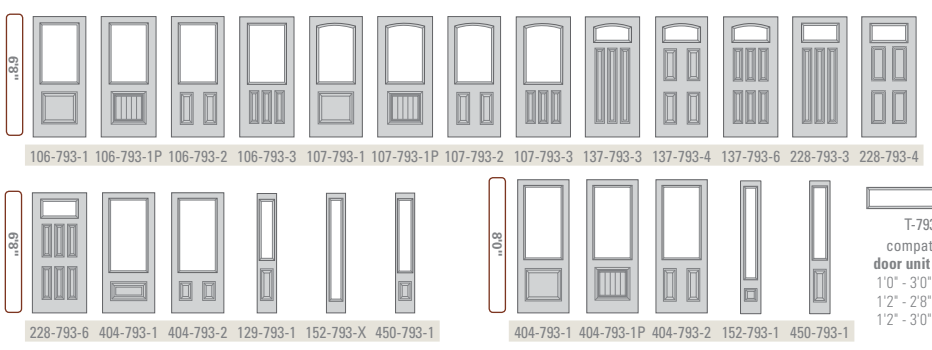

T-793
compatible
door unit sizes:
1'0" - 3'0" - 1'0"
1'2" - 2'8" - 1'2"
1'2" - 3'0" - 1'2"

All color images of doors represent 6'0" configurations. See line art chart for 8'0" door configurations. For specific door availability, please refer to charts on pages 104-106.

authentic surpassed quality

alston GLASS

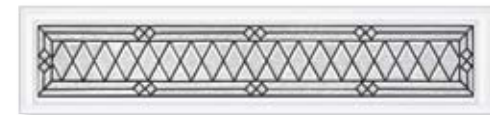

T-338 transom



- BLT Belleville® Oak Textured
- BMT Belleville® Mahogany Textured
- BLS Belleville® Smooth
- OAK Oakcraft®
- SHD Sta-Tru® HD Steel
- MHD Masonite® HD Steel

- BLT
- BMT
- BLS
- OAK
- SHD
- MHD



BMT-122-338-X
2264

- BLT
- BLS

BLT-137-338-3
2210 camber-top



BELLEVILLE® HOLLISTER™ MAHOGANY TEXTURED with Alston™ glass — door BMT-404-338-1 — sidelite BMTSL-450-338-1 — transom T-338



antique black
338caming

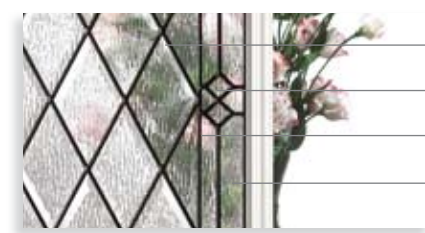

- clear beveled glass
- granite glass
- antique black caming
- tempered surf glass (interior side of lite)



- tempered clear glass (faces outside house)
- decorative core
- tempered surf glass



The Alston family features tempered surf glass. This unique art glass further enhances the privacy and elegance of this series.

Alston™ 338antique black

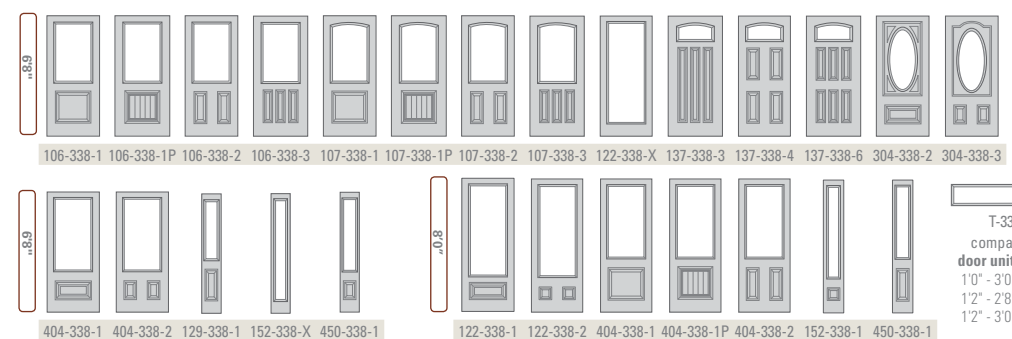

BELLEVILLE® SMOOTH with Alston™ glass BL-106-338-3

appealing choices

aria
.....GLASS

spectacular



BELLEVILLE® HOLLISTER™ MAHOGANY with Aria™ glass – door BMT-404-455-1



charcoal spectraweld™ 455

Featuring SpectraWeld™ technology, a unique system utilizing revolutionary composite material that bonds to the glass and simulates caming.

Aria™ 455 charcoal spectraweld™

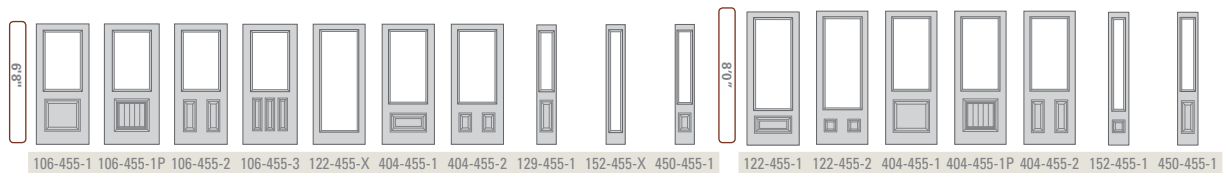

All color images of doors represent 6'8" configurations. See line art chart for 8'0" door configurations. For specific door availability, please refer to charts on pages 104-106.

<p>BLT BLS SHD MHD</p> <p>BMT-106-455-1 2236</p>	<p>BLS MHD</p> <p>MHD-106-455-1P 2236</p>	<p>BLT BMT BLS OAK SHD MHD</p> <p>BMT-106-455-2 2236</p>
<p>BLT BLS</p> <p>BLS-106-455-2 2236</p>	<p>BLT BMT BLS OAK SHD MHD</p> <p>BMT-122-455-X 2264</p>	<p>BLT BLS OAK SHD MHD</p> <p>BMT-404-455-2 2248</p>
<p>BLT BMT BLS OAK SHD MHD</p> <p>BMTSL-129-455-1 836</p>	<p>BLT BMT BLS OAK SHD MHD</p> <p>OAKSL-152-455-X 764</p>	<p>BLT BMT BLS OAK SHD MHD</p> <p>MHD-450-455-1 848</p>

- BLT Belleville® Oak Textured
- BMT Belleville® Mahogany Textured
- BLS Belleville® Smooth
- OAK Oakcraft®
- SHD Sta-Tru® HD Steel
- MHD Masonite® HD Steel

BELLEVILLE® OAK TEXTURED with Aria™ glass BLS-106-455-3

Least Obscure 1 2 3 4 5 6 7 8 9 Most Obscure

charcoal spectraweld™
grey tinted oceana glass
tempered oceana glass



BMT-404-455-1
2248

mondrian GLASS

Featuring SpectraWeld™ technology, a unique system utilizing revolutionary composite material that bonds to the glass and simulates coming.



BELLEVILLE® SMOOTH with Mondrian™ glass – door BLS-404-833-2 – sidelite BLSL-450-833-1

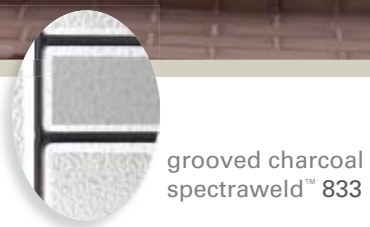
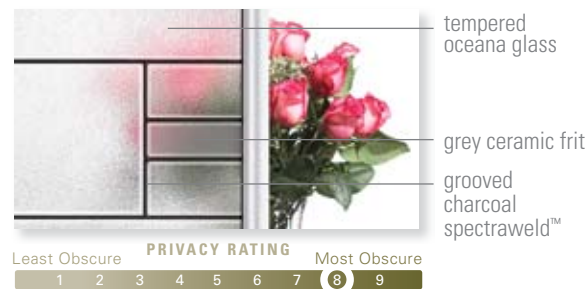

grooved charcoal spectraweld™ 833

- **BLT** Belleville® Oak Textured
- **BMT** Belleville® Mahogany Textured
- **BLS** Belleville® Smooth
- **OAK** Oakcraft®
- **SHD** Sta-Tru® HD Steel
- **MHD** Masonite® HD Steel

Mondrian™ 833 grooved charcoal spectraweld™

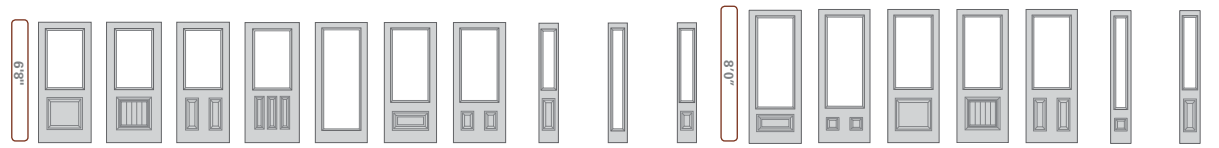

106-833-1 106-833-1P 106-833-2 106-833-3 122-833-X 404-833-1 404-833-2 129-833-1 152-833-X 450-833-1 122-833-1 122-833-2 404-833-1 404-833-1P 404-833-2 152-833-1 450-833-1

All color images of doors represent 6'8" configurations. See line art chart for 8'0" door configurations. For specific door availability, please refer to charts on pages 104-106.

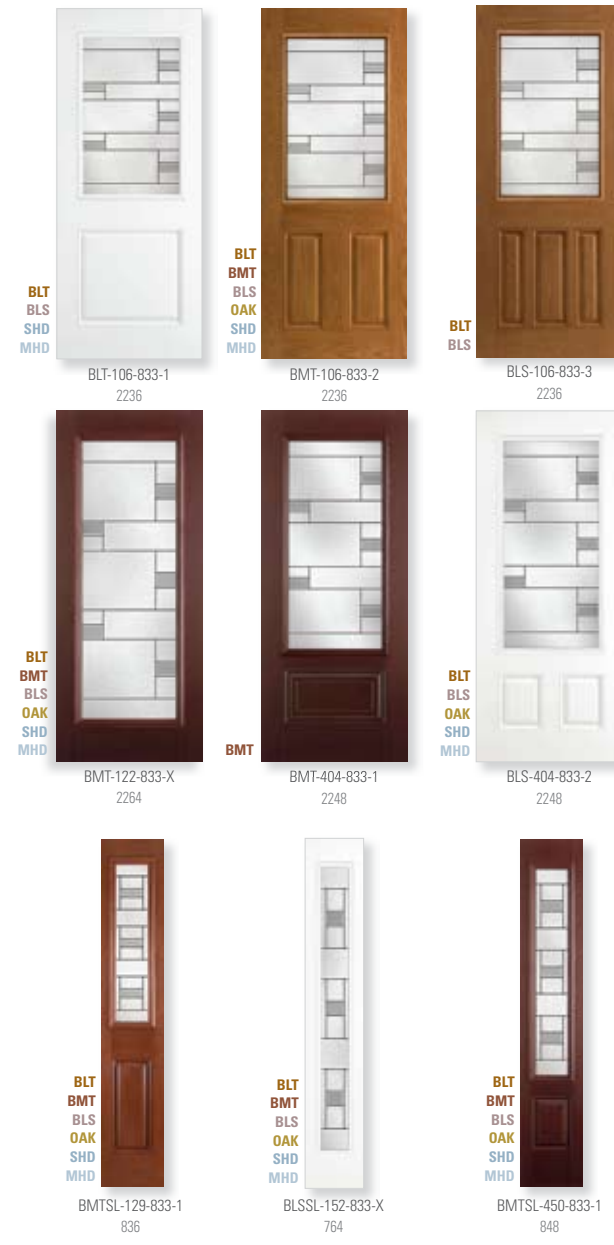

BLS-106-833-1
2236

impressive detail

rockland

GLASS

ROCKLAND™ GLASS 566 ANTIQUE BLACK

ROCKLAND™ GLASS 566 ANTIQUE BLACK



BELLEVILLE® SMOOTH with Rockland™ glass — door BLS-404-566-2 — sidelite BLSL-450-566-1



- antique black caming
- clear beveled glass
- granite glass
- clear swirl glass



antique black 566caming

- BLT Belleville® Oak Textured
- BMT Belleville® Mahogany Textured
- BLS Belleville® Smooth
- OAK Oakcraft®
- SHD Sta-Tru® HD Steel
- MHD Masonite® HD Steel



Rockland 566antique black

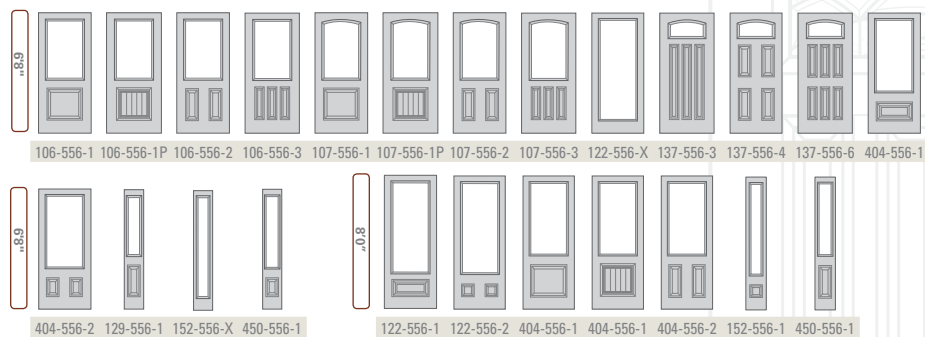

All color images of doors represent 6'8" configurations. See line art chart for 8'0" door configurations. For specific door availability, please refer to charts on pages 104-106.



grand impressions

www.masonite.com

www.masonite.com



STA-TRU® HD STEEL with Monaco™ glass -- door SHD-122-315-X -- sidelite SHDSL-152-315-X -- transom T-315

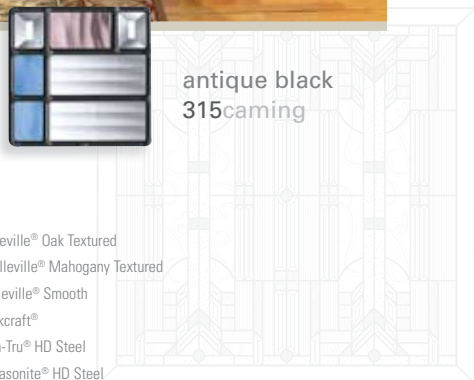
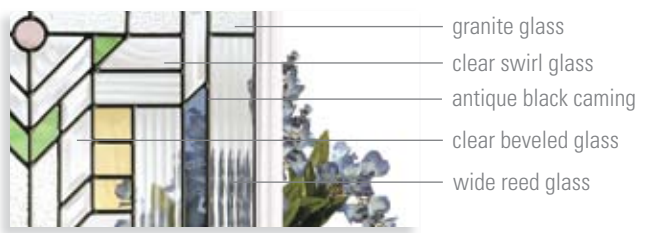

antique black
315caming

- BLT Belleville® Oak Textured
- BMT Belleville® Mahogany Textured
- BLS Belleville® Smooth
- OAK Oakcraft®
- SHD Sta-Tru® HD Steel
- MHD Masonite® HD Steel

PRIVACY RATING										
Least Obscure	1	2	3	4	5	6	7	8	9	Most Obscure
								8		

Monaco™ 315antique black

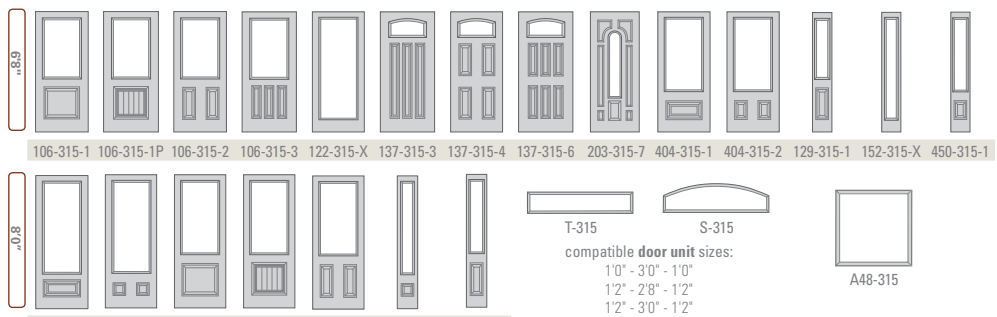

122-315-1 122-315-2 404-315-1 404-315-1P 404-315-2 152-315-1 450-315-1
All color images of doors represent 6'8" configurations. See line art chart for 8'0" door configurations. For specific door availability, please refer to charts on pages 104-106.

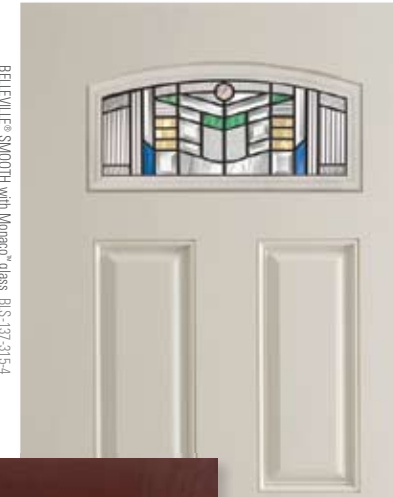
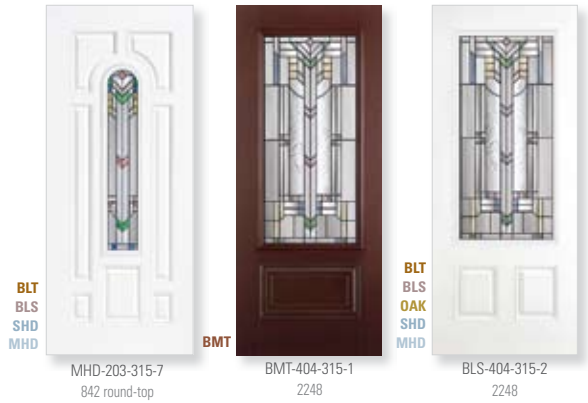

splash of color



naples GLASS

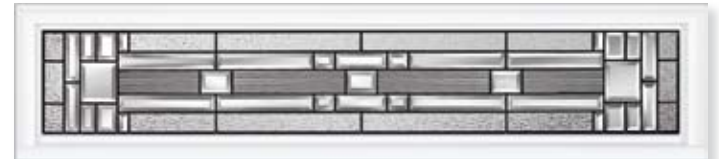
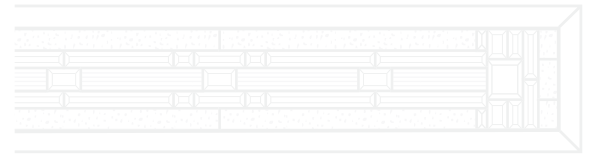

T-366 transom



BLT
BLS
SHD
MHD

SHD-106-366-1
2236

BLS
MHD

MHD-106-366-1P
2236

BLT
BMT
BLS
OAK
SHD
MHD

BMT-106-366-2
2236



BLT
BMT
BLS
OAK
SHD
MHD

BMT-122-366-X
2264

BLT
BLS
SHD
MHD

SHD-203-366-7
842 round-top

BMT

BMT-404-366-1
2248



BLT
BLS
OAK
SHD
MHD

BLT-404-366-2
2248

BLT
BMT
BLS
OAK
SHD
MHD

MHD SL-129-366-1
836

BLT
BMT
BLS
OAK
SHD
MHD

BMT SL-152-366-X
764

BLT
BMT
BLS
OAK
SHD
MHD

BLT SL-450-366-1
848

BLT
BMT
BLS
OAK
SHD
MHD

BLT SL-852-366-X
880

BLT
BMT
BLS
OAK
SHD
MHD

BLS-810-366-X
2280

HD STEEL with Naples™ glass – door MHD-106-366-2 – sidelite MHD SL-129-366-1 – transom T-366

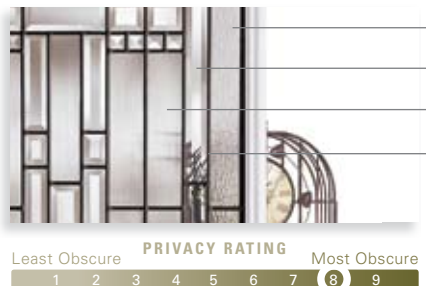

- granite glass
- clear beveled glass
- narrow reed glass
- antique black caming



antique black 366 caming



Naples™ 366 antique black



All color images of doors represent 6'8" configurations. See line art chart for 8'0" door configurations. For specific door availability, please refer to charts on pages 104-106.

- BLT Belleville® Oak Textured
- BMT Belleville® Mahogany Textured
- BLS Belleville® Smooth
- OAK Oakcraft®
- SHD Sta-Tru® HD Steel
- MHD Masonite® HD Steel



A48-366

captivating



BLT-106-366-3
2236



zavalla GLASS



DOOR COMBINATIONS	Option 1	Option 2	Option 3	Option 4	Option 5	Option 6	Option 7	Option 8
D	()	()						
SD	(())	(())	()	()				
DS	(())	(())	()	()				
SDS	(())	(())	(())	(())	(())	(())	(())	(())
DD	(())	(())	(())	(())	(())	(())	(())	(())

D - doorite S - sidelite



Zavalla glass options are limited only by your imagination. No lefts or rights, no ups and downs, no rules – each Zavalla insert is designed to be rotated – the orientation and arrangement of each insert in your door system is entirely reflective of your own personal wishes.

HD STEEL with Zavalla™ glass – door MHD-122-537-X – sidelite MHDSL-152-537-X



platinum 537 caming

- **BLT** Belleville® Oak Textured
- **BMT** Belleville® Mahogany Textured
- **BLS** Belleville® Smooth
- **OAK** Oakcraft®
- **SHD** Sta-Tru® HD Steel
- **MHD** Masonite® HD Steel



Zavalla™ 537platinum

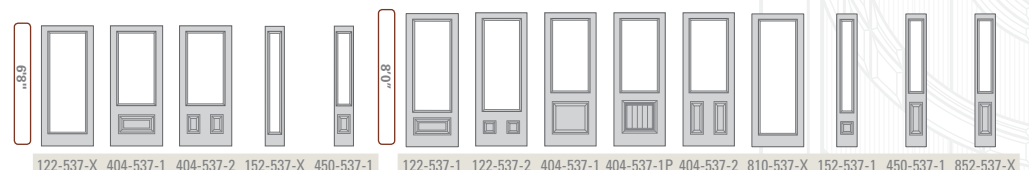

122-537-X 404-537-1 404-537-2 152-537-X 450-537-1 122-537-1 122-537-2 404-537-1 404-537-1P 404-537-2 810-537-X 152-537-1 450-537-1 852-537-X

All color images of doors represent 68" configurations. See line art chart for 810" door configurations. For specific door availability, please refer to charts on pages 104-106.



unique options

quattro
GLASS



T-957 transom



BLT-404-957-2
2248



BELLEVILLE® SMOOTH with Quattro™ glass BLS-106-957-3



BELLEVILLE® MAHOGANY TEXTURED with Quattro™ glass BMT-122-957-X

BELLEVILLE® HOLLISTER™ MAHOGANY TEXTURED with Quattro™ glass – door BMT-404-957-1 – sidelite BMTSL-450-957-1 – transom T-957



tempered oceania glass
(faces inside house)
wrought iron



wrought iron957

Least Obscure PRIVACY RATING Most Obscure
1 2 3 4 5 6 7 8 9

Dynamic expressions

compatible door unit sizes:
10" - 30" - 10"
12" - 28" - 12"
12" - 30" - 12"
T-957

Quattro™ 957wrought iron



106-957-1 106-957-1P 106-957-2 106-957-3 122-957-X 404-957-1 404-957-2 129-957-1 152-957-X 450-957-1 122-957-1 122-957-2 404-957-1 404-957-1P 404-957-2 152-957-1 450-957-1

All color images of doors represent 6'8" configurations. See line art chart for 8'0" door configurations. For specific door availability, please refer to charts on pages 104-106.

- BLT Belleville® Oak Textured
- BMT Belleville® Mahogany Textured
- BLS Belleville® Smooth
- OAK Oakcraft®
- SHD Sta-Tru® HD Steel
- MHD Masonite® HD Steel

marquise GLASS



- BLT Belleville® Oak Textured
- BMT Belleville® Mahogany Textured
- BLS Belleville® Smooth
- OAK Oakcraft®
- SHD Sta-Tru® HD Steel
- MHD Masonite® HD Steel

BELLEVILLE® SMOOTH with Marquise™ glass — door BLS-122-779-X — sidelite BLSSL-152-779-X

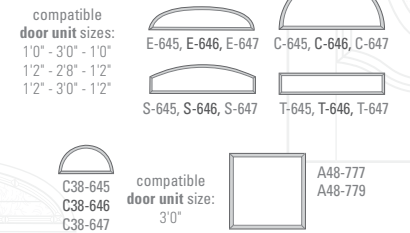

Marquise™ 777brass 778platinum 779antique black 645brass 646platinum 647antique black



All color images of doors represent 6'8" configurations. See line art chart for 8'0" door configurations. For specific door availability, please refer to charts on pages 104-106.

transforms light into brilliance



BELLEVILLE® HOLLISTER™ MAHOGANY TEXTURED with Aurora™ glass – door BMT-304-207-2 – sidelite BMTSL-450-207-1 – transom T-207



- granite beveled glass
- glue chip beveled glass
- zipper bevel glass
- platinum caming
- granite glass
- aqua glass



- BLT Belleville® Oak Textured
- BMT Belleville® Mahogany Textured
- BLS Belleville® Smooth
- OAK Oakcraft®
- SHD Sta-Tru® HD Steel
- MHD Masonite® HD Steel

platinum
207caming

aurora
GLASS

T-207 transom 1

SHD-105-207-2 2236 round-top

BLS-105-207-3 2236 round-top

BLS-106-207-1 2236

MHD-106-207-1P 2236

BMT-106-207-2 2236

BLS-106-207-3 2236

BMT-122-207-X 2264

BLS-203-207-7 842 round-top

SHD-300-207-X 2057 oval

BMT-304-207-2 1640 oval

BLT-304-207-3 1640 oval

BMT-404-207-1 2248

MHD-404-207-2 2248

BLTSL-129-207-1 836

BMTSL-152-207-X 764

BLSL-200-207-1 836 round-top

BMTSL-450-207-1 848

Aurora™207platinum

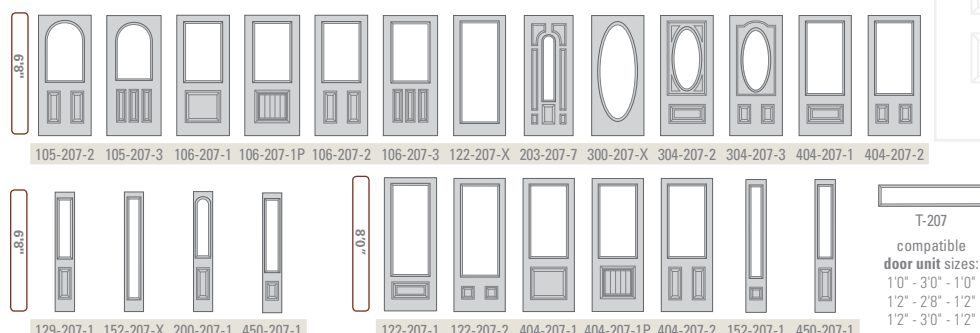

All color images of doors represent 6'8" configurations. See line art chart for 8'0" door configurations. For specific door availability, please refer to charts on pages 104-106.

elegant detail

BELLEVILLE® OAK TEXTURED with Aurora™ glass BLT-203-207-7



BELLEVILLE® SMOOTH with Aurora™ glass BLS-106-207-3



BELLEVILLE® OAK TEXTURED with Aurora™ glass BLT-203-207-7

oxford GLASS

- BLT Belleville® Oak Textured
- BMT Belleville® Mahogany Textured
- BLS Belleville® Smooth
- OAK Oakcraft®
- SHD Sta-Tru® HD Steel
- MHD Masonite® HD Steel



BELLEVILLE® HOLLISTER™ MAHOGANY TEXTURED with Oxford™ glass – door BMT-404-137-1



v-groove
137

Oxford 137v-groove

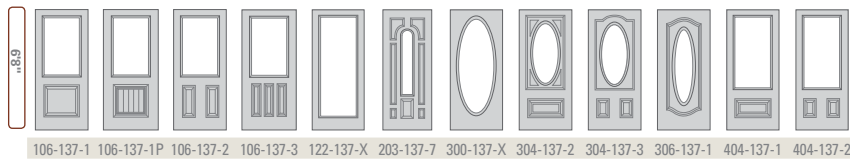

106-137-1 106-137-1P 106-137-2 106-137-3 122-137-X 203-137-7 300-137-X 304-137-2 304-137-3 306-137-1 404-137-1 404-137-2

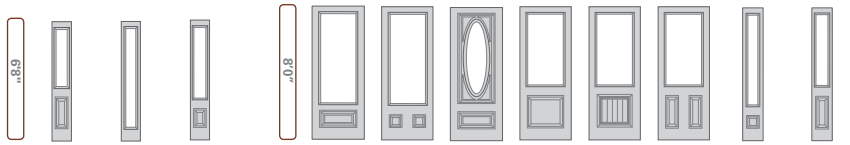

129-137-1 152-137-X 450-137-1 122-137-1 122-137-2 306-137-2 404-137-1 404-137-1P 404-137-2 152-137-1 450-137-1



A48-137

All color images of doors represent 6'8" configurations. See line art chart for 8'0" door configurations. For specific door availability, please refer to charts on pages 104-106.

BLT BLS SHD MHD BLS-106-137-1 2236

BLS MHD MHD-106-137-1P 2236

BLT BMT BLS OAK SHD MHD BLS-106-137-2 2236

BLS BLS BMT-106-137-3 2236

BLT BMT BLS OAK SHD MHD BLS-122-137-X 2264

BLS BLS SHD MHD BMT-203-137-7 842 round-top

BLS BLS OAK SHD MHD SHD-300-137-X 2057 oval

BMT BMT-304-137-2 1640 oval

BLT BLS OAK SHD MHD MHD-304-137-3 1640 oval

BLS BLS OAK SHD MHD BLS-404-137-2 2248

BLT BMT BLS OAK SHD MHD MHD-129-137-1 836

BMT BMT BLS OAK SHD MHD BMTSL-152-137-X 764

BMT BMT BLS OAK SHD MHD BMTSL-450-137-1 848



HD STEEL with Oxford™ glass MHD-304-137-3



BMT-404-137-1 2248



BLT BMT BLS OAK SHD MHD BMT-306-137-1 1555 oval



Least Obscure PRIVACY RATING Most Obscure
1 2 3 4 5 6 7 8 9

aesthetically pleasing



panama
GLASS



BELLEVILLE® OAK TEXTURED with Panama™ glass -- door BLT-122-725-X -- sidelite BLTSL-152-725-X -- transom E-725



- BLT Belleville® Oak Textured
- BMT Belleville® Mahogany Textured
- BLS Belleville® Smooth
- OAK Oakcraft®
- SHD Sta-Tru® HD Steel
- MHD Masonite® HD Steel

brass
724caming

platinum
725caming

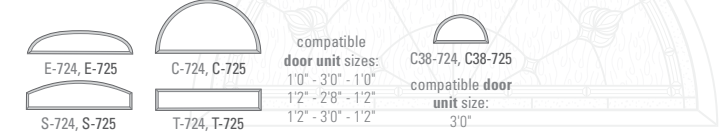

Panama™ 724brass 725platinum



129-724-1 151-724-X 152-724-X 200-724-1 450-724-1 122-724-1 122-724-2 201-724-7 306-724-2 404-724-1 404-724-1P 404-724-2 810-724-X 152-724-1 450-724-1 852-724-X 129-725-1 151-725-X 152-725-X 200-725-1 450-725-1 122-725-1 122-725-2 201-725-7 306-725-2 404-725-1 404-725-1P 404-725-2 810-725-X 152-725-1 450-725-1 852-725-X

All color images of doors represent 6'8" configurations. See line art chart for 8'0" door configurations. For specific door availability, please refer to charts on pages 104-106.

inviting entrances

georgian
GLASS



BELLEVILLE® OAK TEXTURED with Georgian™ glass -- door BLT-107-517-3

glue chip glass
clear beveled glass
platinum caming option

Least Obscure PRIVACY RATING Most Obscure
1 2 3 4 5 6 **7** 8 9

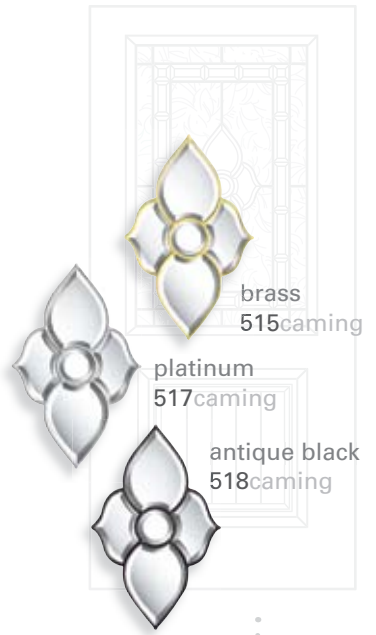

- BLT Belleville® Oak Textured
- BMT Belleville® Mahogany Textured
- BLS Belleville® Smooth
- OAK Oakcraft®
- SHD Sta-Tru® HD Steel
- MHD Masonite® HD Steel



E-645 transom S-646 transom T-647 transom C38-645 transom

BLT BLS OAK SHD MHD BLT BLS BLT BLS SHD MHD BLS MHD BLT BMT BLS OAK SHD MHD

BLS-105-515-2 2236 round-top BLT BLS BLT-105-517-3 2236 round-top BLT BLS SHD MHD BLT-106-517-1 2236 BLS MHD MHD-106-518-1P 2236 BLT BMT BLS OAK SHD MHD BLT-106-515-2 2236

SHD MHD SHD-107-515-1 2237 camber-top BLS MHD BLS-107-517-1P 2237 camber-top BLT BLS OAK SHD MHD BLT-107-517-2 2237 camber-top BLT BLS BLT-107-517-3 2237 camber-top BLT BMT BLS OAK SHD MHD BLS-122-517-X 2264

OAK SHD MHD SHD-136-517-8 718 BLT BLS OAK SHD MHD BLT-300-515-X 2057 oval BLT BLS OAK SHD MHD BLS-304-517-3 1640 oval BLT BLT-306-517-1 1555 oval BMT BMT-404-517-1 2248

BLT BLS OAK SHD MHD BLS-404-515-2 2248 BLT BMT BLS OAK SHD MHD MHD SL-129-518-1 836 BLT BMT BLS OAK SHD MHD BLSSL-152-517-X 764 BLT BLS OAK SHD MHD BLTSL-200-517-1 836 round-top BLT BMT BLS OAK SHD MHD BMTSL-450-517-1 848

BLS-106-518-3 2236

Georgian™ 515brass 517platinum 518antique black 645brass 646platinum 647antique black

105-515-2 105-515-3 106-515-1 106-515-1P 106-515-2 106-515-3 107-515-1 107-515-1P 107-515-2 107-515-3 122-515-X 136-515-8 300-515-X 304-515-2 304-515-3 306-515-1 404-515-1 404-515-2 105-517-2 105-517-3 106-517-1 106-517-1P 106-517-2 106-517-3 107-517-1 107-517-1P 107-517-2 107-517-3 122-517-X 136-517-8 300-517-X 304-517-2 304-517-3 306-517-1 404-517-1 404-517-2 106-518-1 106-518-1P 106-518-2 106-518-3

129-515-1 152-515-X 200-515-1 450-515-1 129-517-1 152-517-X 200-517-1 450-517-1 129-518-1 122-515-1 122-515-2 306-515-2 404-515-1 404-515-1P 404-515-2 152-515-1 450-515-1 122-517-1 122-517-2 306-517-2 404-517-1 404-517-1P 404-517-2 152-517-1 450-517-1

E-645, E-646, E-647 C-645, C-646, C-647 C38-645 C38-646 C38-647
S-645, S-646, S-647 T-645, T-646, T-647 compatible door unit size: 10" - 30" - 10" 12" - 28" - 12" 12" - 30" - 12" door unit size: 30"

All color images of doors represent 6'8" configurations. See line art chart for 8'0" door configurations. For specific door availability, please refer to charts on pages 104-106.

exceptional quality



HD STEEL with Woodbridge™ glass - door MHD-106-921-1P



- granite glass
- clear beveled glass
- glue chip glass
- brass caming option



brass caming
442
727
920

platinum caming
443
728
921

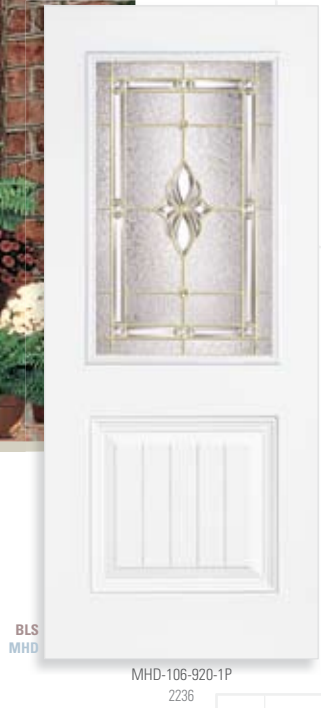

MHD-106-920-1P
2236

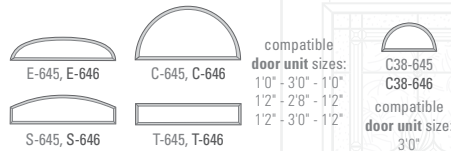

Woodbridge GLASS



 BLT BLS OAK SHD MHD BLT-106-920-2 2236 round-top	 BLT BLS BLT-106-920-3 2236 round-top	 BLT BLS SHD MHD MHD-106-920-1 2236	 BLT BLS BLT-106-921-3 2236	 BMT BLS OAK SHD MHD BMT-106-920-2 2236
 BMT BLS OAK SHD MHD BMT-122-442-X 2264	 BLT BLS BLS-137-920-3 2210 camber-top	 BLT BLS OAK SHD MHD BLT-137-921-4 2210 camber-top	 BLT BLS BLT-137-921-6 2210 camber-top	 BLT BLS BLT-228-920-3 2210
 BLT BLS OAK BLT-228-921-4 2210	 BLT BLS BLS-228-920-6 2210	 BLT BLS OAK SHD MHD SHD-300-442-X 2057 oval	 BMT BLS OAK SHD MHD BMT-304-443-2 1640 oval	 BLT BLS OAK SHD MHD BLS-304-442-3 1640 oval
 BLT BLT-306-443-1 1555 oval	 BLT BLS OAK SHD MHD BLS-404-443-2 2248	 BLT BLS OAK SHD MHD MHDSSL-450-728-1 848	 BLT BLS OAK SHD MHD BLTSL-200-920-1 836 round-top	 BLT BLS OAK SHD MHD BLSSL-152-921-X 764
 BLT BLS OAK SHD MHD BMTSL-152-727-X 764	 BLT BLS OAK SHD MHD BMTSL-129-920-1 836	 BMT BLS OAK SHD MHD BMT-404-442-1 2248		

Woodbridge™ 442 • 727 • 920 brass 443 • 728 • 921 platinum 645 brass 646 platinum

105-920-2	105-920-3	106-920-1	106-920-1P	106-920-2	106-920-3	122-442-X	137-920-X	137-920-4	137-920-6	228-920-3	228-920-4	228-920-6	300-442-X	304-442-2	304-442-3	306-442-1
106-921-1	106-921-1P	106-921-2	106-921-3	122-443-X	137-921-X	137-921-4	137-921-6	228-921-3	228-921-4	228-921-6	300-443-X	304-443-2	304-443-3	306-443-1		
404-442-1	404-442-2	129-920-1	152-727-X	152-920-X	200-920-1	450-920-1	122-442-1	122-442-2	306-442-2	404-442-1	404-442-1P	404-442-2	152-727-1	152-920-1	450-727-1	
404-443-1	404-443-2	129-921-1	152-728-X	152-921-X	450-921-1		122-443-1	122-443-2	306-443-2	404-443-1	404-443-1P	404-443-2	152-728-1	152-921-1	450-728-1	

All color images of doors represent 6'8" configurations. See line art chart for 8'0" door configurations. For specific door availability, please refer to charts on pages 104-106.

simply beautiful



T-856 transom

victorian GLASS

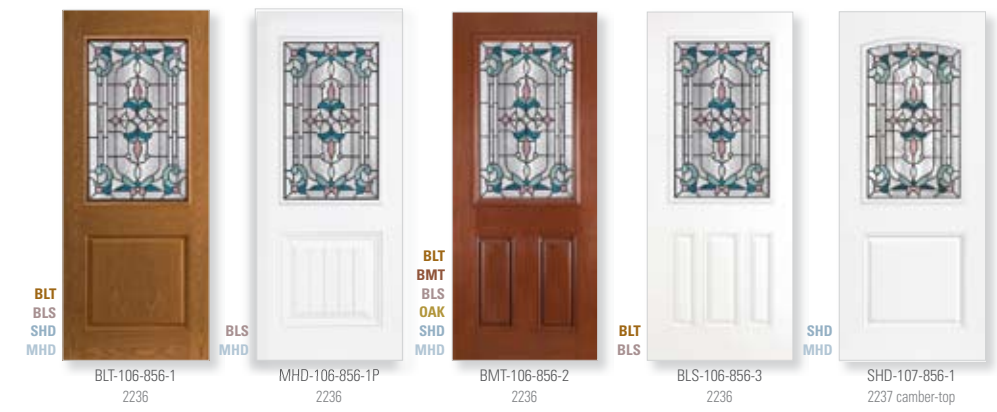

BLT
BLS
SHD
MHD

BLT-106-856-1
2236

BLS
MHD

MHD-106-856-1P
2236

BLT
BMT
BLS
OAK
SHD
MHD

BMT-106-856-2
2236

BLS
MHD

BLS-106-856-3
2236

SHD
MHD

SHD-107-856-1
2237 camber-top

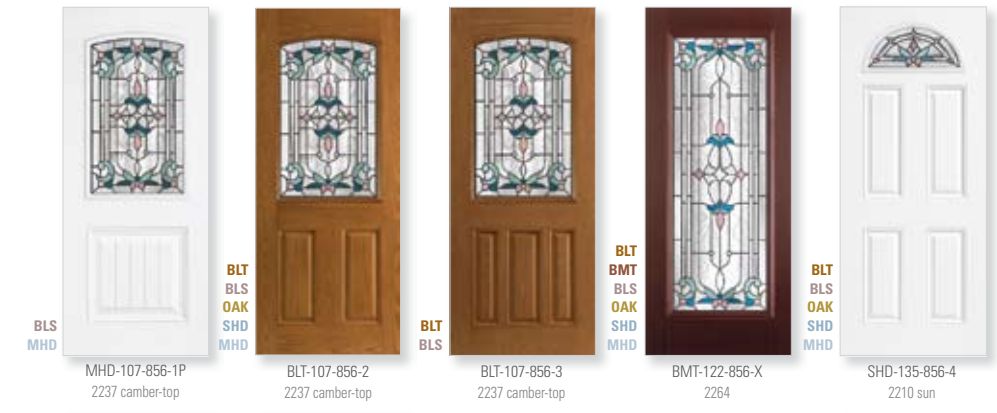

BLS
MHD

MHD-107-856-1P
2237 camber-top

BLT
BLS
OAK
SHD
MHD

BLT-107-856-2
2237 camber-top

BLT
BLS

BLT-107-856-3
2237 camber-top

BLT
BMT
BLS
OAK
SHD
MHD

BMT-122-856-X
2264

BLT
BLS
OAK
SHD
MHD

SHD-135-856-4
2210 sun

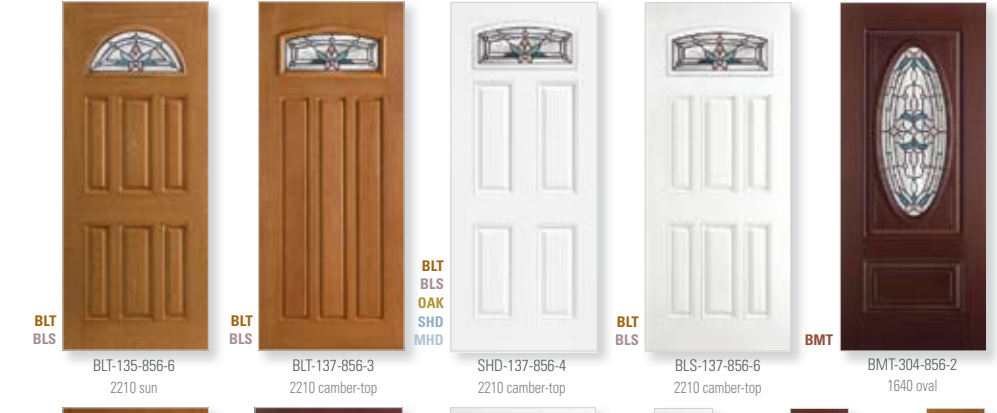

BLT
BLS

BLT-135-856-6
2210 sun

BLT
BLS

BLT-137-856-3
2210 camber-top

BLT
BLS
OAK
SHD
MHD

SHD-137-856-4
2210 camber-top

BLT
BLS

BLS-137-856-6
2210 camber-top

BMT

BMT-304-856-2
1640 oval

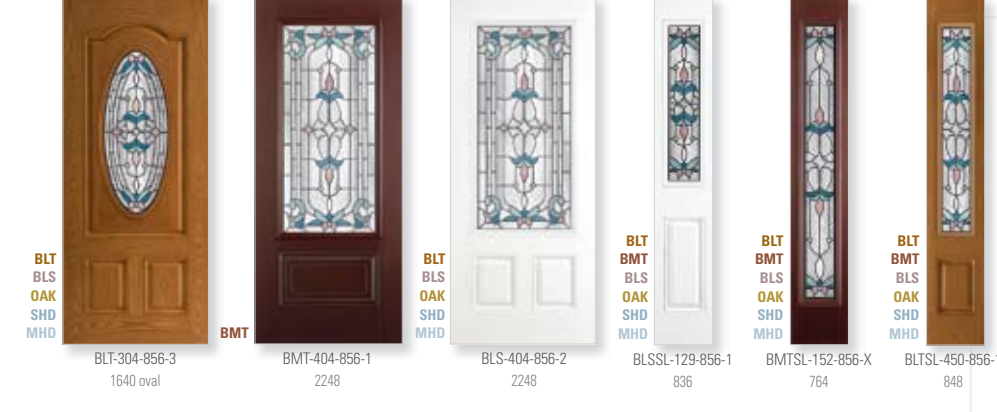

BLT
BLS
OAK
SHD
MHD

BLT-304-856-3
1640 oval

BMT

BMT-404-856-1
2248

BLT
BLS
OAK
SHD
MHD

BLS-404-856-2
2248

BLT
BMT
BLS
OAK
SHD
MHD

BLSL-129-856-1
836

BLT
BMT
BLS
OAK
SHD
MHD

BMTSL-152-856-X
764

BLT
BMT
BLS
OAK
SHD
MHD

BLTSL-450-856-1
848

BELLEVILLE™ SMOOTH with Victorian™ glass BLS-106-856-1



antique black
856caming

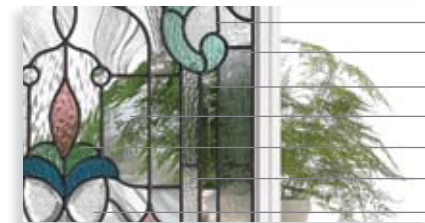

- antique black caming
- glue chip glass
- zipper bevel glass
- clear swirl glass
- aqua glass
- granite glass
- granite beveled glass

- BLT Belleville® Oak Textured
- BMT Belleville® Mahogany Textured
- BLS Belleville® Smooth
- OAK Oakcraft®
- SHD Sta-Tru® HD Steel
- MHD Masonite® HD Steel

Least Obscure **PRIVACY RATING** Most Obscure

1 2 3 4 5 6 7 **8** 9

Victorian™ 856antique black

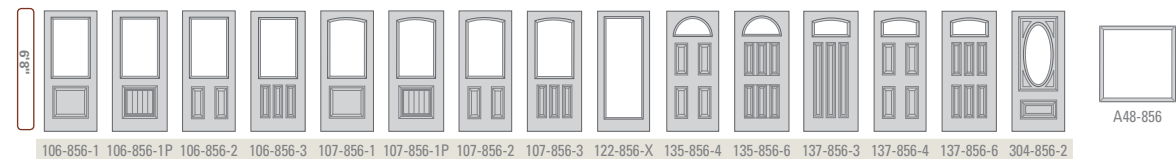

106-856-1 106-856-1P 106-856-2 106-856-3 107-856-1 107-856-1P 107-856-2 107-856-3 122-856-X 135-856-4 135-856-6 137-856-3 137-856-4 137-856-6 304-856-2

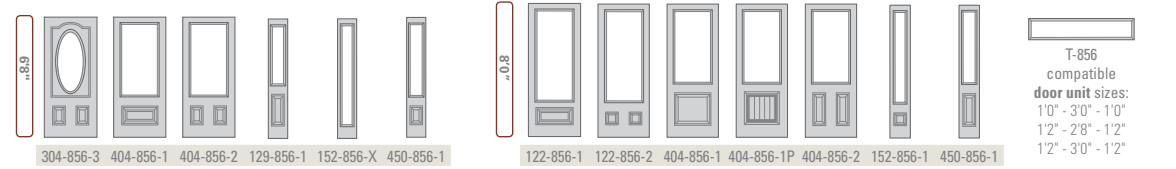

304-856-3 404-856-1 404-856-2 129-856-1 152-856-X 450-856-1 122-856-1 122-856-2 404-856-1 404-856-1P 404-856-2 152-856-1 450-856-1

T-856
compatible
door unit sizes:
1'0" - 3'0" - 1'0"
1'2" - 2'8" - 1'2"
1'2" - 3'0" - 1'2"

All color images of doors represent 6'8" configurations. See line art chart for 8'0" door configurations. For specific door availability, please refer to charts on pages 104-106.

enchanting



BELLEVILLE® CHEYENNE SMOOTH with Fundy™ glass – door BLS-106-264-1P



etched glass
clear glass



Fundy™ 264etched

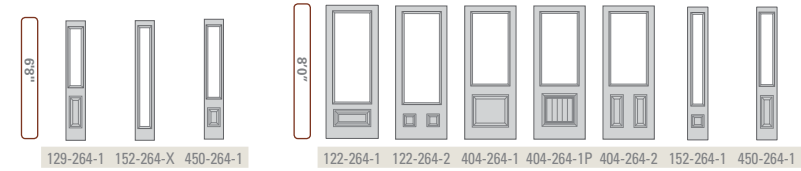
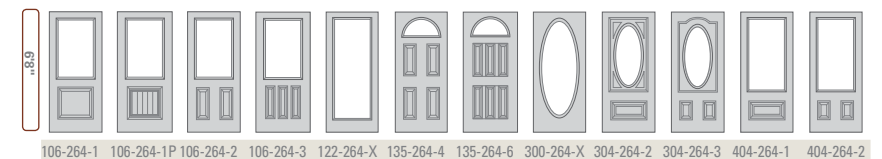

All color images of doors represent 6'8" configurations. See line art chart for 8'0" door configurations. For specific door availability, please refer to charts on pages 104-106.

Fundy GLASS

BLT
BLS
SHD
MHD

BLS
MHD

BLT
BMT
BLS
OAK
SHD
MHD

BLT
BLS

BMT

BLT
BLS
OAK
SHD
MHD

BMT
BLS
OAK
SHD
MHD

BMT

BLT
BLS
OAK
SHD
MHD

BLT
BMT
BLS
OAK
SHD
MHD

BLT
BMT
BLS
OAK
SHD
MHD

BLT
BMT
BLS
OAK
SHD
MHD

BLT
BLS
OAK
SHD
MHD

BLT
BLS

BLT-106-264-1 2236

BLS-106-264-1P 2236

BLT-106-264-2 2236

BLS-106-264-3 2236

BMT-404-264-1 2248

SHD-135-264-4 2210 sun

BMT-122-264-X 2264

BLT-300-264-X 2057 oval

BMT-304-264-2 1640 oval

BLT-404-264-2 2248

BMTSL-129-264-1 836

BLTSL-152-264-X 764

BLSSL-450-264-1 848

BLT-135-264-6 2210 sun

- BLT Belleville® Oak Textured
- BMT Belleville® Mahogany Textured
- BLS Belleville® Smooth
- OAK Oakcraft®
- SHD Sta-Tru® HD Steel
- MHD Masonite® HD Steel

quality characteristics

InternalBlinds 010 tilonly 01RL raise&lower-tilt

Imagine a blind you don't have to dust or clean. Our blinds are built-into efficient sealed units protected with tempered glass. A single touch easily opens/closes blinds for privacy and light exposure.

	B106-010-2 B106-01RL-2	B106-09E-2	B120-010-X B120-01RL-X	B122-010-X B122-01RL-X	B120-150E-X B122-150E-X	B160-010-2 B160-01RL-2	B404-010-2	B129-010-1	B152-010-X	B450-010-1	B810-010-X B810-01RL-X	B820-010-X B820-01RL-X
BLT	•	•	•	•	•	•	•	•	•	•	•	•
BMT*	-	-	-	-	-	-	-	-	-	-	-	-
BLS	•	•	•	•	•	•	•	•	•	•	•	•
OAK	•	•	•	•	•	•	•	•	•	•	•	•
SHD	•	•	•	•	•	•	•	•	•	•	•	•
MHD	•	•	•	•	•	•	•	•	•	•	•	•
MUS	•	•	•	•	•	•	•	•	•	•	•	•

Venting Inserts 010onelite

Our venting inserts are virtually maintenance free and will not yellow or crack.

	V106-010-2	V120-010-X	V122-010-X	V160-010-2	V404-010-2	V129-010-1	V151-010-X	I standard internalgrille	clearglass			
BLT	•	•	•	•	•	•	•	•	•	•	•	•
BMT*	-	-	-	-	-	-	-	-	-	-	-	-
BLS	•	•	•	•	•	•	•	•	•	•	•	•
OAK	•	•	•	•	•	•	•	•	•	•	•	•
SHD	•	•	•	•	•	•	•	•	•	•	•	•
MHD	•	•	•	•	•	•	•	•	•	•	•	•
MUS	•	•	•	•	•	•	•	•	•	•	•	•

ExternalGrilleInserts E standard externalgrille††

	105-11E-2	106-09E-2	107-09E-2	120-10E-X	122-10E-X	120-15E-X	122-15E-X	133-05E-4	135-05E-4	137-05E-4	160-09E-2	822-04E-4	129-03E-1	152-05E-X	200-03E-1	810-18E-X
BLT	•	•	•	•	•	•	•	•	•	•	•	•	•	•	•	•
BMT*	-	-	-	-	-	-	-	-	-	-	-	-	-	-	-	-
BLS	•	•	•	•	•	•	•	•	•	•	•	•	•	•	•	•
OAK	•	•	•	•	•	•	•	•	•	•	•	•	•	•	•	•
SHD	•	•	•	•	•	•	•	•	•	•	•	•	•	•	•	•
MHD	•	•	•	•	•	•	•	•	•	•	•	•	•	•	•	•
MUS	•	•	•	•	•	•	•	•	•	•	•	•	•	•	•	•

MHD and SHD doors are available with Wood-Edge or Steel-Edge construction. MUS doors are Wood-Edge only. Wood-Edge sidelites are utilized on all MUS, MHD and SHD door units.
 *Almond stainable frames are not available. *Mahogany tinted frames are not available, however, BMT doors are physically compatible with BLT inserts.
 ††Simulated divided lite options using extruded PVC lineals are available in select configurations.

SDL Simulated Divided Lite

	C120-08S	C122-08S	C152-04S	C404-04S	C404-06S	C450-02S	C450-03S
BLT	•	•	•	•	•	•	•
BMT*	-	-	-	-	-	-	-
BLS	•	•	•	•	•	•	•
OAK	•	•	•	•	•	•	•
SHD	•	•	•	•	•	•	•
MHD	•	•	•	•	•	•	•
MUS	•	•	•	•	•	•	•

SDL's only available with white Centurion frames to match BLS, SHD, MHD and MUS product lines.

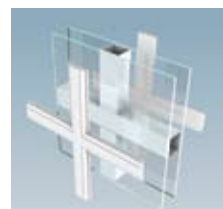

SDL Simulated Divided Lite

- 1-1/8" external grille
- aluminium internal grille
- traditional look and warmth of a true divided lite wood door combined with the benefits of modern construction techniques
- manufactured using warm edge technology
- all units come standard with Low-E and Argon

clear Lites clearglass

OneLite 010 standard onelite

	105-010-2	106-010-2	107-010-2	108-010-X	109-010-X	114-010-X	120-010-X	122-0101-X	135-010-4	136-010-8	137-010-4	160-010-2	228-010-4
BLT	•	•	•	•	•	•	•	•	•	•	•	•	•
BMT*	-	-	-	-	-	-	-	-	-	-	-	-	-
BLS	•	•	•	•	•	•	•	•	•	•	•	•	•
OAK	•	•	•	•	•	•	•	•	•	•	•	•	•
SHD	•	•	•	•	•	•	•	•	•	•	•	•	•
MHD	•	•	•	•	•	•	•	•	•	•	•	•	•
MUS	•	•	•	•	•	•	•	•	•	•	•	•	•

InternalGrilleInserts I standard internalgrille P prairie internalgrille clearglass

	105-11I-2	106-09I-2	107-09I-2	109-17I-X	114-10I-X	120-10I-X	122-10I-X	120-15I-X	122-15I-X	135-05I-4	160-09I-2	228-06I-4	404-12I-2
BLT	•	•	•	•	•	•	•	•	•	•	•	•	•
BMT*	-	-	-	-	-	-	-	-	-	-	-	-	-
BLS	•	•	•	•	•	•	•	•	•	•	•	•	•
OAK	•	•	•	•	•	•	•	•	•	•	•	•	•
SHD	•	•	•	•	•	•	•	•	•	•	•	•	•
MHD	•	•	•	•	•	•	•	•	•	•	•	•	•
MUS	•	•	•	•	•	•	•	•	•	•	•	•	•

Internal Grille Types
 (specify grille type when ordering)
 All grille styles are not available in all lite sizes. See price book for detailed offering list.

- A** White Slimline 1/4" x 5/16"
- B** White Traditional 1/4" x 5/8"
- C** White Wide Traditional 3/8" x 7/8"
- D** White Georgian 5/16" x 5/8"
- E** Sandlewood Traditional 1/4" x 5/8"
- G** Brass Slimline 1/4" x 5/16"
- H** Tudor 1/4" x 5/8"
- M** Antique Black 1/4" x 5/8"

MHD and SHD doors are available with Wood-Edge or Steel-Edge construction. MUS doors are Wood-Edge only. Wood-Edge sidelites are utilized on all MUS, MHD and SHD door units.
 † Almond stainable frames are not available. *Mahogany tinted frames are not available, however, BMT doors are physically compatible with BLT inserts.

entry systems



BELLEVILLE® SMOOTH with Quarto™ glass door BLS-106-957-1 sidelite BLSL-129-957-1

1 Composite Backed Sills

✓ A key to preventing water intrusion is properly sealing the bottom of the sill to the foundation. Our composite material will not rot and makes proper installation easy.

2 Astragal

✓ Premium thermal astragals with locking flush bolts and durable rubber boots seal off the elements with the performance to fit almost any application. (double doors only)

3 Weather Tight

✓ Compression weather stripping seals the edges of the doors and helps prevent water and air infiltration. Composite bottom door rail with sweep will not rot and fend off drafts.

4 Premium Construction

✓ Continuous head and sill construction maximizes the stability and rigidity of the assembled system while eliminating potential sources for water intrusion. Mull boots ease installation and keep components above potential water.

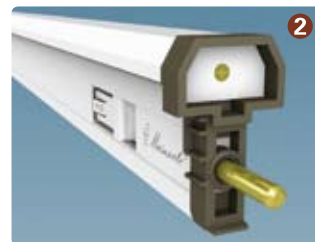
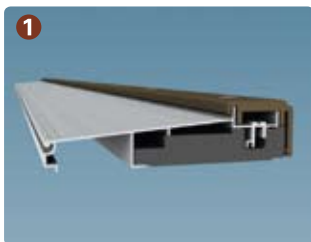

Components shown are representative examples.

NOTE: Mill finish is standard on all sills. Brass or bronze finishes are also available.

U-Install® replacement frames make it easy for you.

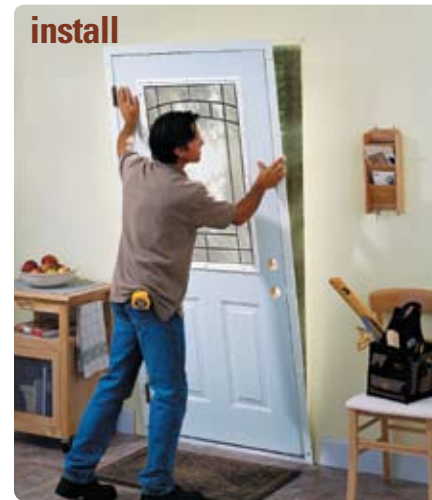

quick&easy installation

No need to remove the old frames or hassle with complicated installation procedures. Just measure the width and height of the opening and order the frame components, door and sill. When they arrive, remove your old door, trim and threshold then assemble the new components with the replacement door and install inside your existing door frame.

u-install frame kits

- ✓ pre-primed and ready to paint
- ✓ matches Prem spec door hinge patterns
- ✓ can be paired with either our steel or fiberglass doors
- ✓ constructed from quality heavy duty steel
- ✓ limited 10 year warranty

replacement size doors

- ✓ undersized to fit directly into your new frames
- ✓ can be fitted with your choice of our specialty glass
- ✓ wide variety of styles and configurations available

replacement doors

door sizes available

door style	flush	4 panel blank top	6 panel
2'6" x 6'8"	✓		✓
2'8" x 6'8"	✓	✓	✓
3'0" x 6'8"	✓	✓	✓

sizes

If your existing frame measures between:

Minimum Width	Maximum Width	Door Size
29-3/4"	30-1/2"	2'6"
31-3/4"	32-1/2"	2'8"
35-3/4"	36-1/2"	3'0"

Minimum Height	Maximum Height	Door Size
80"	80-1/2"	6'8"
84"	84-1/2"	7'0"

adjustable steel door frames

THE ULTIMATE ADJUSTABLE KERFED STEEL DOOR FRAME

FAST-FRAME's advanced design adds a new dimension of flexibility and durability to Masonite's steel entry door line. Developed and manufactured exclusively for Masonite by TIMELY®, FAST-FRAME™ features a full 1" of adjustability to accommodate almost any variation in wall construction. This easy-to-install, user-friendly, kerfed steel door frame system is applicable to a full range of residential and commercial applications – wood or steel stud construction. TIMELY's expertise in innovating and manufacturing steel door frame components is second to none. FAST-FRAME is engineered to meet the most stringent code requirements including structural, impact and 90-minute fire ratings.

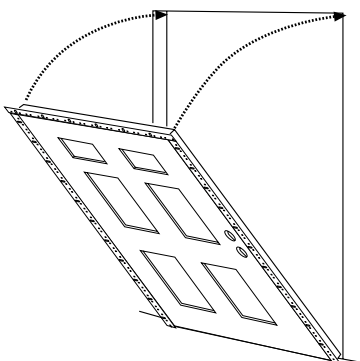

SILLS

Standard Inswing
Thermally broken – 5-5/8" width
Optional extenders for larger wall sizes
Note: Not for use on outswing applications.



Handicap (ADA)
Double Slope 5" and 7" width



Tile Face 5" and 7" width
Note: Not for use on outswing applications.

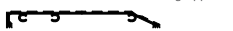

Bumper Outswing 4-1/2" width



OUTER ADJUSTABLE CLOSURE

20-gauge steel
2 uprights – 1 header

TA-1 ADJUSTABLE T-STRIKE

1/4" of adjustment allows for ease of field installations for proper door closure

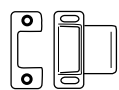

CLOSURE SPAN ADJUSTMENT CHART

Wall Size	A
4-1/2" – 5-1/2" = 1-7/8"	
5-1/2" – 6-1/2" = 2-7/8"	
6-1/2" – 7-1/2" = 3-7/8"	

Wider sizes are available upon request.

WEATHERSTRIPPING

Schlegel foam-filled compression (QEBD500)
90-minute fire rating

PRIME BRIGHT WHITE EG

Galvanized 20-gauge steel provides superior corrosion resistance and an optimal surface for painting



- Double door width is with a "Z" astragal. If using a 5/8" astragal then add 9/16" to the width
- All dimensions shown are for doors with standard inswing sill. Deduct 13/16" for bumper outswing or handicap compliant sill
- Add 4" to height for 7'0" height
- Add 16" to height for 8'0" height
- Premdor spec slabs add 1/4" to height

FAST-FRAME™ Rough Openings

Prehung door sizes

	Nominal Door Size		Rough Opening Size (wood stud)	
	Width	Height	Width	Height
Single door	2'0"	6'8"	25-1/4"	81-3/8"
	2'6"	6'8"	31-1/4"	81-3/8"
	2'8"	6'8"	33-1/4"	81-3/8"
	2'10"	6'8"	35-1/4"	81-3/8"
	3'0"	6'8"	37-1/4"	81-3/8"
Double door	4'0"	6'8"	49-5/32"	81-3/8"
	5'0"	6'8"	61-5/32"	81-3/8"
	5'4"	6'8"	65-5/32"	81-3/8"
	5'8"	6'8"	69-5/32"	81-3/8"
	6'0"	6'8"	73-5/32"	81-3/8"

CASING OPTIONS



Wood trim and brickmould can be easily applied to Fast-Frame using nails or trim head screws without the need for custom millwork.

FAST-FRAME CASINGS

TA-8 STANDARD STEEL CASING

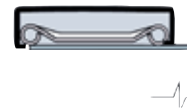

TA-30 COLONIAL STEEL CASING

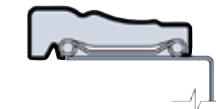

- TA-8 casings enhance any commercial or residential setting.
- TA-30 casings add a special warmth for assisted living, motels, hotels, offices, apartments and homes.

It is recommended that TA-18 retainer clips be used for both casings.

APPLICATIONS

- Multi-Family • Assisted Living • Motel/Hotel
- House to Garage • Garage to Exterior



FIRE LABELS

- 90-Minute Fire Rating
- up to 3'0" x 8'0" Single
- up to 6'0" x 7'0" Double

CLOSURE TEST

In a 90-minute application, the door will close and latch from 18" if the following Fast-Frame components are used:

- QEBD500 Foam-Filled Compression Weatherstripping
- Factory Sweep • Adjustable T-Strike • Factory Supplied Sills



STRUCTURAL PERFORMANCE AND IMPACT RATING

Design pressure ratings are available for compliance with national, state and local wind load and/or missile requirements. Product approval under the Miami-Dade BCCO NOA or Intertek Testing Services/Warnock Hersey® programs.

DOOR SELECTION

Fast-frame is available in either right- or left-hand inswing or outswing, and is for use with any Masonite steel entry door.

easy-to-install

MASONITE™ HD 6 panel steel door



entry systems

rough openings

new construction size

SINGLE DOOR

Nominal Door Size		Door Unit Actual Size		Rough Opening Size (wood stud)		Outside Brickmould Size	
Width	Height	Width	Height*	Width	Height*	Width	Height*
2'6"	6'8"	31-1/2"	81-1/2"	32-1/4"	82"	34"	82-3/4"
2'8"	6'8"	33-1/2"	81-1/2"	34-1/4"	82"	36"	82-3/4"
2'8"	8'0"	33-1/2"	97-1/2"	34-1/4"	98"	36"	98-3/4"
3'0"	6'8"	37-1/2"	81-1/2"	38-1/4"	82"	40"	82-3/4"
3'0"	8'0"	37-1/2"	97-1/2"	38-1/4"	98"	40"	98-3/4"

All dimensions shown are for inswing doors – deduct 1-1/8" from the actual door size, the rough opening size and the outside brickmould size height for outswing or handicap accessible doors. See product selection detailed in the Catalog to determine if the entry door style you have selected is available. Recommended rough openings for the FAST-FRAME™ adjustable steel frame offering are different than the dimensions shown in this chart – see rough opening chart titled FAST-FRAME. Floor covering can affect rough opening heights.

SINGLE DOOR WITH ONE L/H OR R/H SIDELITE

Nominal Door Size		Nominal Sidelite Size		Door Unit Actual Size		Rough Opening Size (wood stud)		Outside Brickmould Size	
Width	Height	Width	Height	Width	Height*	Width	Height*	Width	Height*
2'6"	6'8"	10"	6'8"	43"	81-1/2"	43-3/4"	82"	45-1/2"	82-3/4"
2'6"	6'8"	10"	6'8"	45"	81-1/2"	45-3/4"	82"	47-1/2"	82-3/4"
2'6"	6'8"	12"	6'8"	47"	81-1/2"	47-3/4"	82"	49-1/2"	82-3/4"
2'8"	6'8"	10"	6'8"	45"	81-1/2"	45-3/4"	82"	47-1/2"	82-3/4"
2'8"	6'8"	10"	6'8"	47"	81-1/2"	47-3/4"	82"	49-1/2"	82-3/4"
2'8"	6'8"	12"	6'8"	49"	81-1/2"	49-3/4"	82"	51-1/2"	82-3/4"
2'8"	8'0"	10"	8'0"	47"	97-1/2"	47-3/4"	98"	49-1/2"	98-3/4"
2'8"	8'0"	12"	8'0"	49"	97-1/2"	49-3/4"	98"	51-1/2"	98-3/4"
3'0"	6'8"	10"	6'8"	49"	81-1/2"	49-3/4"	82"	51-1/2"	82-3/4"
3'0"	6'8"	10"	6'8"	51"	81-1/2"	51-3/4"	82"	53-1/2"	82-3/4"
3'0"	6'8"	12"	6'8"	53"	81-1/2"	53-3/4"	82"	55-1/2"	82-3/4"
3'0"	8'0"	10"	8'0"	51"	97-1/2"	51-3/4"	98"	53-1/2"	98-3/4"
3'0"	8'0"	12"	8'0"	53"	97-1/2"	53-3/4"	98"	55-1/2"	98-3/4"

All dimensions shown are for inswing doors – deduct 1-1/8" from the actual door size, the rough opening size and the outside brickmould size height for outswing or handicap accessible doors. See product selection detailed in the Catalog to determine if the entry door style you have selected is available. Floor covering can affect rough opening heights.

*Height dimensions shown are for 79" and 96" tall doors with 1-1/4" sills, for variations adjust accordingly.

SINGLE DOOR WITH TWO SIDELITES

Nominal Door Size		Nominal Sidelite Size		Door Unit Actual Size		Rough Opening Size (wood stud)		Outside Brickmould Size	
Width	Height	Width	Height	Width	Height*	Width	Height*	Width	Height*
2'6"	6'8"	10"	6'8"	54-1/2"	81-1/2"	55-1/4"	82"	57"	82-3/4"
2'6"	6'8"	10"	6'8"	58-3/8"	81-1/2"	59-1/8"	82"	60-7/8"	82-3/4"
2'6"	6'8"	12"	6'8"	62-3/8"	81-1/2"	63-1/8"	82"	64-7/8"	82-3/4"
2'8"	6'8"	10"	6'8"	56-1/2"	81-1/2"	57-1/4"	82"	59"	82-3/4"
2'8"	6'8"	10"	6'8"	60-3/8"	81-1/2"	61-1/8"	82"	62-7/8"	82-3/4"
2'8"	6'8"	12"	6'8"	64-3/8"	81-1/2"	65-1/8"	82"	66-7/8"	82-3/4"
2'8"	8'0"	10"	8'0"	60-3/8"	97-1/2"	61-1/8"	98"	62-7/8"	98-3/4"
2'8"	8'0"	12"	8'0"	64-3/8"	97-1/2"	65-1/8"	98"	66-7/8"	98-3/4"
3'0"	6'8"	10"	6'8"	60-1/2"	81-1/2"	61-1/4"	82"	63"	82-3/4"
3'0"	6'8"	10"	6'8"	64-3/8"	81-1/2"	65-1/8"	82"	66-7/8"	82-3/4"
3'0"	6'8"	12"	6'8"	68-3/8"	81-1/2"	69-1/8"	82"	70-7/8"	82-3/4"
3'0"	8'0"	10"	8'0"	64-3/8"	97-1/2"	65-1/8"	98"	66-7/8"	98-3/4"
3'0"	8'0"	12"	8'0"	68-3/8"	97-1/2"	69-1/8"	98"	70-7/8"	98-3/4"

All dimensions shown are for inswing doors – deduct 1-1/8" from the actual door size, the rough opening size and the outside brickmould size height for outswing handicap accessible doors. See product selection detailed in the Catalog to determine if the entry door style you have selected is available. Floor covering can affect rough opening heights.

Rough opening for units with transoms:

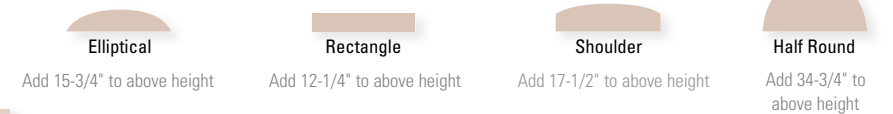

DOUBLE DOOR

Nominal Door Size		Door Unit Actual Size		Rough Opening Size (wood stud)		Outside Brickmould Size	
Width	Height	Width	Height*	Width	Height*	Width	Height*
5'0"	6'8"	62"	81-1/2"	62-3/4"	82"	64-1/2"	82-3/4"
5'4"	6'8"	66"	81-1/2"	66-3/4"	82"	68-1/2"	82-3/4"
5'4"	8'0"	66"	97-1/2"	66-3/4"	98"	68-1/2"	98-3/4"
6'0"	6'8"	74"	81-1/2"	74-3/4"	82"	76-1/2"	82-3/4"
6'0"	8'0"	74"	97-1/2"	74-3/4"	98"	76-1/2"	98-3/4"

All dimensions shown are for inswing doors – deduct 1-1/8" from the actual door size, the rough opening size and the outside brickmould size height for outswing handicap accessible doors. See product selection detailed in the Catalog to determine if the entry door style you have selected is available. Recommended rough openings for the FAST-FRAME™ adjustable steel frame offering are different than the dimensions shown in this chart – see rough opening chart titled FAST-FRAME. Floor covering can affect rough opening heights.

*Height dimensions shown are for 79" and 96" tall doors with 1-1/4" sills, for variations adjust accordingly.

Masonite® Patio & Flush-glazed doors

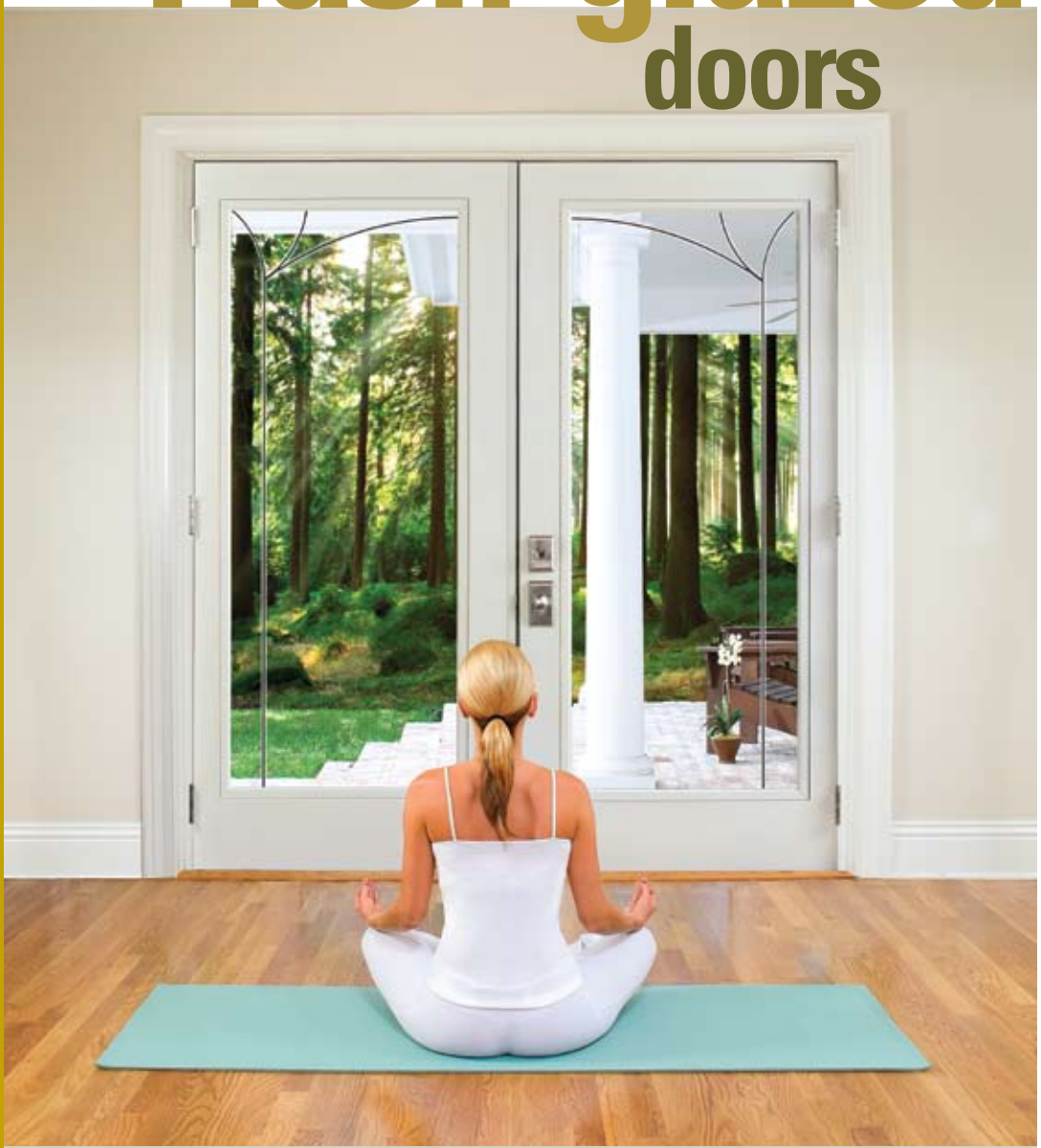

FLUSH-GLAZED BELLEVILLE® with Trella™ glass

Upgrade to Flush-Glaze Fiberglass Door Panels More View, Less Maintenance

Wider Viewing Area

- ✓ 2'8" and 3'0" full lite units are available with up to a 20% wider viewing area

Less Maintenance:

- ✓ Compact profile holds less dust than conventional frames
- ✓ Simple profile is also easier to clean
- ✓ Fiberglass door panels will not dent or rust

Outstanding Aesthetics

- ✓ No screw holes or plugs
- ✓ Clean, simple glazing profile

Less Inventory

- ✓ Masonite's full lite flush glaze system allows for field assembly, so less inventory is required



Masonite® Patio System Elegant Designs, Certified Performance

Awe inspiring views and ample natural light are just on the other side of the wall. Why not let them in with a touch of style and a heap of energy saving, dependable performance.

Introducing the NEW Masonite® Patio door system featuring rich options such as: SpectraWeld™ designer glass, flush-glazed door panels, and premium frame components to make the ultimate passage from your home to the outdoors.



How we Build our Patio system



1 Composite Backed Sills

- ✓ A key to preventing water intrusion is properly sealing the bottom of the sill to the foundation. Our composite material will not rot and makes proper installation easy.



4 Weather Tight

- ✓ Compression weather stripping seals the edges of the doors and helps prevent water and air infiltration. Composite bottom door rail with sweep will not rot and fend off drafts.



2 Vinyl Jambs

- ✓ Full composite jambs are pre-finished white, never rot and are maintenance free. Wood frames are available as an option.



5 Premium Construction

- ✓ Continuous head and sill construction maximizes the stability and rigidity of the assembled system while eliminating potential sources for water intrusion. Mull boots ease installation and keep components above potential water.



3 Astragal

- ✓ Premium thermal astragals with locking flush bolts and durable rubber boots seal off the elements with the performance to fit almost any application.



6 180° Open System

- ✓ Specially designed hinging system allows the doors to open up a full 180° and fold flat against your home, creating more space.

elegant patio designs

The new Masonite patio door collection features SpectraWeld™ technology on select decorative glass panels. This unique system utilizes revolutionary composite material that bonds to the glass and simulates coming without the associated limitations such as panel size, air infiltration, weight and rattling.

Masonite Patio systems are available for sale as NFRC certified units in fully assembled or knock-down kits, with Low-E configurations qualifying for the tax credit. Door panels are also available in standard and flush-glaze configurations.

The designer collection comes standard with Low-E glass to make the system more energy efficient in both the summer and winter and also allows it to be tax credit eligible.

energy tax credit eligible



see page 95

jasmine™ GLASS

Gentle creeping etched vines entangle around a light pattern to create an opulent gateway to your outdoor retreat.



Above image enhanced to show subtle design details, see side photography for best representation.

Configuration Options



LOW-E IS STANDARD

trella™ GLASS

Inspired by the gentle arches of a trellis, this unique design frames your beautiful deck, garden, or patio vista and creates an inviting passage to your home or outdoor living area.



Configuration Options

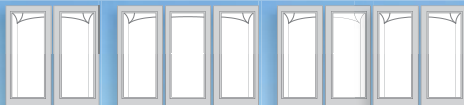

LOW-E IS STANDARD

redmont™ GLASS

An elegant border encases your new patio doors bringing sophistication and elegance without overpowering your view of the outdoors.



Configuration Options

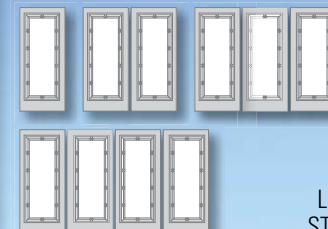

LOW-E IS STANDARD

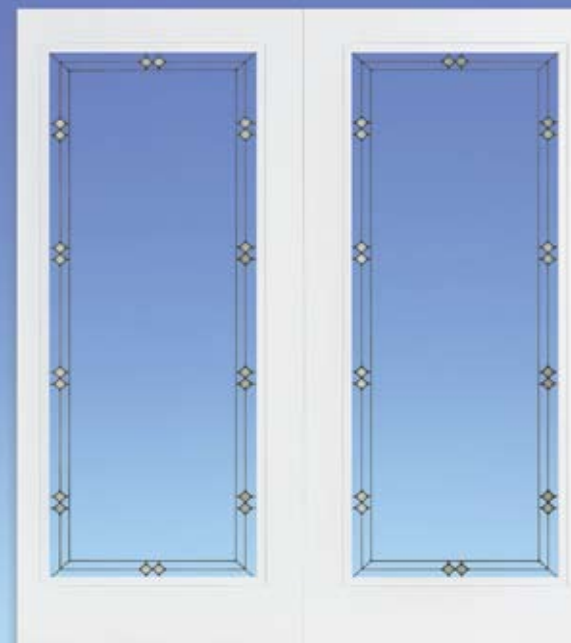

Above image enhanced to show subtle design details, see side photography for best representation.

mondrian™ GLASS

SpectraWeld™ and a light ceramic coating are used to create a cubist pattern that is balanced and symmetrical. This universal design is equally at home in a variety of settings including urban, southwest, and modern motifs.

Configuration Options



LOW-E IS STANDARD



Image enhanced to show subtle design details, see side photography for best representation.

centennial 15™ GLASS

The classic leaded 15 pane glass design has been upgraded to be more quite, energy efficient, and durable through the use of our SpectraWeld™ technology.

Configuration Options



LOW-E IS STANDARD



traditional patio designs

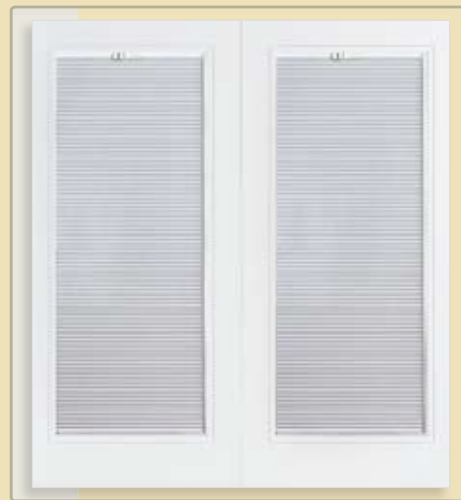

internal mini-blinds

- Our raise / lower mini-blinds have just been upgraded and are now able to be used in a flush-glazed door system.
- With a quick adjustment you can go from clear views to complete privacy and the blinds never need cleaned.

Configuration Options



LOW-E IS OPTIONAL

Flush-Glazed half lite door panels

factory-glazed options



9 lite clear grille between glass and 9 lite clear low-e grille between glass

half lite clear and half lite low-e clear



ten lites



fifteen lites

- Our ten and fifteen lite units are available in internal and external* grid configurations, with and without Low-E coatings. Vented Sidelites are available.

Configuration Options



(10L shown)

LOW-E IS OPTIONAL

*external grids only available in standard glazed systems.



prairie

Prairie
Our SDL bars are used to create a nine lite prairie style design

- Clear and Low-E Clear
Tempered clear glass can be accompanied with a Low-E coating that reflects heat out of the home in the summer and locks in heat during the winter. Vented Sidelites are available.

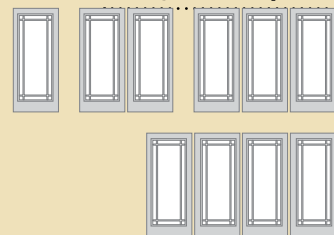

Configuration Options



one lite clear & low-e clear



LOW-E IS OPTIONAL

	FIBERGLASS		HD STEEL
	OAKCRAFT® TEXTURED	BELLEVILLE® SMOOTH	MASONITE® HD
	 Mix and match high-performing natural wood-grain textured door designs with your choice of decorative glass.	 Sleek look with a variety of door and glass options to choose from, engineered for performance.	 High-definition panel profile offering the security of 24-gauge steel for years of performance.
Wood Door Authenticity	★★★ Fine	★★★ Fine	★★ Good
Wood Grain Texture	Traditional oak	Ultra-smooth	Smooth
Edge (Stile) Construction	True square-edge	True square-edge	Interlocking
Edge (Stile) Material	Stainable/paintable wood	Paintable wood	Paintable wood or steel
Finish Options	Stain or paint	Paint	Paint
Durability & Performance	Lifetime warranty ¹	Lifetime warranty ¹	5-15 years ¹
Composite Bottom Rail	✓	✓	✓
Rust Proof	✓	✓	✓
Dent Proof	✓	✓	✓
ENERGY STAR*	✓	✓	✓
Glazing Options	Flush/Standard	Flush/Standard	Standard
Glass Designs	11+	11+	11+
Glazing Assembly	Traditional glazing inserts	Traditional glazing inserts	Traditional glazing inserts

Flush-Glazed Door Specifications

Door Material	OAKCRAFT® TEXTURED	BELLEVILLE® SMOOTH	MASONITE® HD
Facing Color	White	White	
Height Options	6'8", 8'0"	6'8", 8'0"	
Panel Width	2'6"-3'0"	2'0"-3'0"	
Glass Width	20"-26"	14"-26"	

Standard Glazed Door Specifications

	OAKCRAFT® TEXTURED	BELLEVILLE® SMOOTH	MASONITE® HD
Facing Color	TAN	White	White
Height Options	6'8", 8'0"	6'8", 8'0"	6'8", 8'0"
Panel Width	2'6"-3'0"	2'6"-3'0"	2'6"-3'0"
Glass Width	20"-22"	20"-22"	20"-22"

Patio Configuration Options

Patio Configurations	Vented Sidelite (Single or Double)	Single Door	Double Door	Triple Door	Quad Door*
Heights	6'8", 8'0"	6'8", 8'0"	6'8", 8'0"	6'8", 8'0"	6'8", 8'0"
Widths	13", 16"	2'0"-3'0"	4'0"-6'0"	6'0"-9'0"	8'0"-12'0"
Hinge Options	L,R	L,R	FR, CE	FR	FR, CE
Swing	IS	IS, OS	IS, OS	IS, OS	IS, OS

*A critical component of an ENERGY STAR qualified entryway.
 ▲Continuous head and sill construction available to 9' width.
¹All warranties are limited.

Masonite patio systems

rough openings handing

rough openings retro-fit size



systems

DOUBLE (FRENCH) DOOR

Nominal Door Size		Actual Door Unit Size		Rough Opening Size (wood stud)		Outside Brickmould Size	
Width	Height	Width	Height	Width	Height	Width	Height
5'0"	6'8"	59-1/4"	79-1/2"	60"	80"	61-3/4"	80-3/4"
5'0"	8'0"	59-1/4"	95-1/2"	60"	96"	61-3/4"	96-3/4"
6'0"	6'8"	71-1/4"	79-1/2"	72"	80"	73-3/4"	80-3/4"
6'0"	8'0"	71-1/4"	95-1/2"	72"	96"	73-3/4"	96-3/4"

All dimensions shown are for inswing doors – deduct 1-1/4" from the actual door unit height, the rough opening height and the outside brickmould height for outswinging doors. Width dimensions for active units reflect French door sizes. Floor covering can affect rough opening heights. All dimensions listed have a tolerance of +/- 3/16".

TRIPLE (FRENCH) DOOR

Nominal Door Size		Actual Door Unit Size		Rough Opening Size (wood stud)		Outside Brickmould Size	
Width	Height	Width	Height	Width	Height	Width	Height
9'0"	6'8"	107-5/16"	79-1/2"	108-1/16"	80"	109-13/16"	80-3/4"

All dimensions shown are for inswing doors – deduct 1-1/4" from the actual door unit height, the rough opening height and the outside brickmould height for outswinging doors. Floor covering can affect rough opening heights. All dimensions listed have a tolerance of +/- 3/16".

DOUBLE (CENTER-SWING) DOOR

Nominal Door Size		Actual Door Unit Size		Rough Opening Size (wood stud)		Outside Brickmould Size	
Width	Height	Width	Height	Width	Height	Width	Height
5'0"	6'8"	59-3/4"	79-1/2"	60-1/2"	80"	62-1/4"	80-3/4"
5'0"	8'0"	59-3/4"	95-1/2"	60-1/2"	96"	62-1/4"	96-3/4"
6'0"	6'8"	71-3/4"	79-1/2"	72-1/2"	80"	74-1/4"	80-3/4"
6'0"	8'0"	71-3/4"	95-1/2"	72-1/2"	96"	74-1/4"	96-3/4"

All dimensions shown are for inswing doors – deduct 1-1/4" from the actual door unit height, the rough opening height and the outside brickmould height for outswinging doors. Width dimensions for active units reflect French door sizes. Floor covering can affect rough opening heights. All dimensions listed have a tolerance of +/- 3/16".

TRIPLE (CENTER-SWING) DOOR

Nominal Door Size		Actual Door Unit Size		Rough Opening Size (wood stud)		Outside Brickmould Size	
Width	Height	Width	Height	Width	Height	Width	Height
9'0"	6'8"	107-13/16"	79-1/2"	108-9/16"	80"	110-5/16"	80-3/4"

All dimensions shown are for inswing doors – deduct 1-1/4" from the actual door unit height, the rough opening height and the outside brickmould height for outswinging doors. Floor covering can affect rough opening heights. All dimensions listed have a tolerance of +/- 3/16".

Complete list of rough opening sizes available at Masonite.com

door handing chart

FOR MASONITE ENTRY & PATIO DOORS

INSWING		OUTSWING	
DOORS PICTURED ABOVE ASSUME YOU ARE STANDING ON THE OUTSIDE OF THE BUILDING.		DOORS PICTURED ABOVE ASSUME YOU ARE STANDING ON THE OUTSIDE OF THE BUILDING.	
SINGLE DOORS		SINGLE DOORS	
WITH LEFT-HAND SIDELITE		WITH LEFT-HAND SIDELITE	
WITH RIGHT-HAND SIDELITE		WITH RIGHT-HAND SIDELITE	
WITH DOUBLE SIDELITE		WITH DOUBLE SIDELITE	
DOUBLE DOORS		DOUBLE DOORS	
FRENCH SINGLE DOORS		FRENCH SINGLE DOORS	
FRENCH DOUBLE DOORS		FRENCH DOUBLE DOORS	
CENTER-HINGE DOUBLE DOORS		CENTER-HINGE DOUBLE DOORS	
CENTER-HINGE TRIPLE DOORS		CENTER-HINGE TRIPLE DOORS	

Complete list of handing options available at Masonite.com

ENERGY STAR

In 2010 the U.S. ENERGY STAR qualification criteria for a door system is changing. The new criteria eliminates the four climate zone maps that have been used to determine the system qualification performance. Climate zones will be replaced with a nationwide product performance criteria for opaque, less than or equal to 1/2 lite and greater than 1/2 lite qualification criteria.

Masonite doors and sidelites use premium polyurethane insulation and multi-pane insulated glass which creates superior insulating properties and lowers heating and cooling bills. Our NFRC certified assembled door units may qualify for ENERGY STAR 2009, ENERGY STAR 2010, and the current U.S. Federal Tax Credit. Other criteria exists for eligibility in the various programs but use the below charts as a general guideline for which Masonite products qualify.

Both ENERGY STAR and the U.S. Federal Tax Credit criteria are based on the system's performance as measured by the U-Value and the SHGC (Solar Heat Gain Coefficient).

1 U-Factor: Measures the rate of heat transfer through a product. It considers all elements of an assembly including conductivity, air flow, and glass emissivity. A lower U-Factor indicates a better insulating product.

2 SHGC: (Solar Heat Gain Coefficient) Measures the amount of energy that passes through glass from the sun, creating additional heat. The lower the SHGC, the better it blocks solar heat.

potential qualifying Masonite products*



Glass Type	GLAZING LEVEL				
	OPAQUE	1/4 LITE	1/2 LITE	3/4 LITE	FULL LITE
WOOD-EDGE STEEL DOORS	0.14 U-Factor				
Clear 1/2" IG					
Clear 1/2" IG E Grids					
Low-E 1/2" IG					
Low-E 1/2" IG E Grids					
1" IG					
1" IG Int Grids					
Low-E Surface #2 1" IG					
FIBERGLASS DOORS	0.14 U-Factor				
Low-E Surface #2 1" IG E Grids					
Triple Pane Deco IG w/Caming					
Clear 1/2" IG					
Clear 1/2" IG E Grids					
Low-E 1/2" IG					
Low-E 1/2" IG E Grids					
1" IG					
1" IG Int Grids					
Low-E Surface #2 1" IG					
Low-E Surface #2 1" IG E Grids					
Triple Pane Deco IG w/Caming					

2010 ENERGY STAR Product Performance criteria

Glazing Level	U-Factor ¹	SHGC ²
ALL	≤ 0.21	No Rating
≤ 1/2-Lite	≤ 0.27	≤ 0.30
> 1/2-Lite	≤ 0.32	≤ 0.30

¹ Btu/h.ft.² °F
² Fraction of incident solar radiations

TAX CREDIT

In 2009, the American recovery and Reinvestment Act of 2009 was signed into law. This law offers a U.S. Federal Income Tax credit to consumers for eligible doors of up to 30% of the purchase price of the door, with a maximum credit of \$1500. This tax credit is valid through the end of 2010. Please retain the NFRC performance label that is affixed to the door for required proof of product performance.

U.S. FEDERAL TAX CREDIT Product Performance criteria*

Glazing Level	U-Factor ¹	SHGC ²
ALL	≤ 0.30	≤ 0.30

¹ Btu/h.ft.² °F
² Fraction of incident solar radiations
* Other criteria exists for Tax Credit eligibility. Please consult your tax professional.

potential qualifying Masonite products*

Glass Type	GLAZING LEVEL				
	OPAQUE	1/4 LITE	1/2 LITE	3/4 LITE	FULL LITE
WOOD-EDGE STEEL DOORS	0.14 U-Factor				
Clear 1/2" IG					
Clear 1/2" IG E Grids					
Low-E 1/2" IG					
Low-E 1/2" IG E Grids					
1" IG					
1" IG Int Grids					
Low-E Surface #2 1" IG					
FIBERGLASS DOORS	0.14 U-Factor				
Low-E Surface #2 1" IG E Grids					
Triple Pane Deco IG w/Caming					
Clear 1/2" IG					
Clear 1/2" IG E Grids					
Low-E 1/2" IG					
Low-E 1/2" IG E Grids					
1" IG					
1" IG Int Grids					
Low-E Surface #2 1" IG					
Low-E Surface #2 1" IG E Grids					
Triple Pane Deco IG w/Caming					

"IG" = Insulated Glass
*Please verify qualification with the NFRC performance label affixed to the door.

Potential Tax Credit Eligible

"IG" = Insulated Glass
*Please verify qualification with the NFRC performance label affixed to the door.

Projected 2010 ENERGY STAR Qualified

Visit www.masonite.com for more information.

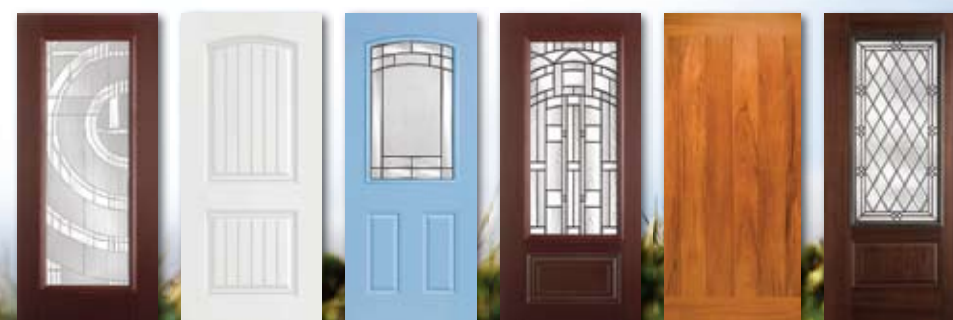

Masonite® steel door selection & style



MASONITE® HD STEEL MHD 2 panel camber-top plank



MASONITE® HD STEEL MHD 2 panel square

touch of style

Masonite® High-Definition Steel door series

Masonite® HD Steel unique features

■ **factory-primed surface**
super-tough, baked-on primer provides superior protection against the elements (finishing required)

■ **high-definition panel profile**
adds a touch of style and distinction and more closely replicates the appearance of a wood door

■ **steel-edge or wood-edge construction**

■ **composite bottom rail**
creates a rot and moisture resistant structure

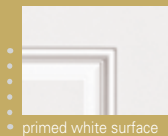

LIMITED 15 YEAR WARRANTY (Steel-Edge)
LIMITED 5 YEAR WARRANTY (Wood-Edge)

	MHD	MHD	MHD	MHD	MHD	MHD	MHD
	FLUSH	2 P SQUARE	2 P CAMBER-TOP	2 P CAMBER-TOP PLANK	2 P W/ 23 X 65 C/O	3 P ARCH-TOP	4 P BLANK-TOP
6'8"	2'0", 2'6", 2'8" 2'10", 3'0"	2'8", 2'10" 3'0"	2'8", 2'10" 3'0"	2'8", 2'10" 3'0"	-	2'8", 2'10" 3'0"	2'6", 2'8" 2'10", 3'0"
7'0"	2'0", 2'6", 2'8" 2'10", 3'0"	3'0"	-	-	-	-	2'6", 2'8" 2'10", 3'0"
8'0"	2'0", 2'6", 2'8" 2'10", 3'0"	-	-	-	2'8", 2'10" 3'0"	-	-
fire door option	2'0", 2'6", 2'8" 2'10", 3'0"	2'8", 2'10" 3'0"	2'8", 2'10" 3'0"	2'8", 2'10" 3'0"	-	2'8", 2'10" 3'0"	-
glass sizes	109, 120, 122 300, 810	106	106, 107	106, 107	122	304 404, 410	105, 106, 107 135, 137

	MHD	MHD	MHD	MHD	MHD	MHD	MHD
	4 P NEW ENGLAND	6 P	8 P PARLAMENT	9 P CAMBER-TOP	FLUSH SIDEITE	1 P SIDEITE w/ 9 X 65 C/O	2 P UNIVERSAL SIDEITE
6'8"	2'8", 2'10" 3'0"	2'6", 2'8" 2'10", 3'0"	2'8", 2'10" 3'0"	2'8", 2'10" 3'0"	10", 1'0", 1'2"	-	1'0", 1'2"
7'0"	-	2'6", 2'8" 2'10", 3'0"	-	-	1'0", 1'2"	-	1'0", 1'2"
8'0"	-	2'8", 2'10" 3'0"	-	-	10", 1'0", 1'2"	1'0", 1'2"	1'0", 1'2"
fire door option	2'10", 3'0"	2'6", 2'8" 2'10", 3'0"	2'8", 2'10" 3'0"	2'8", 2'10" 3'0"	-	-	-
glass sizes	106	106, 120 122, 404, 810	203	136	149, 151 152, 852	151	129, 200, 450 450, 852

† Features narrow panel layout. * Available in Wood-Edge only.
Available as Warnock-Hersey® listed fire door (Wood-Edge is 20-minute only in 6'8" and 7'0" heights, Steel-Edge is 90-minute in 6'8", 7'0" and 8'0" heights, Masonite® HD or Sta-Tru® HD only)

outstanding panel definition

Masonite® Sta-Tru® HD Steel door series

Sta-Tru HD Steel unique features

■ **prefinished white surface**
factory applied white paint provides superior aesthetics and protection against the elements (no finishing required)

■ **high-definition panel profile**
adds a touch of style and distinction and more closely replicates the appearance of a wood door

■ **steel-edge or wood-edge construction**

■ **composite bottom rail**
creates a rot and moisture resistant structure



LIMITED 20 YEAR WARRANTY (Steel-Edge or Wood-Edge)

	SHD	SHD	SHD	SHD	SHD	SHD	SHD
	FLUSH	2 P CAMBER-TOP	2 P W/ 23 X 65 C/O	3 P ARCH-TOP	4 P BLANK-TOP	4 P NEW ENGLAND	6 P
6'8"	2'0", 2'6", 2'8" 2'10", 3'0"	2'8", 2'10" 3'0"	-	2'8", 2'10" 3'0"	2'6", 2'8" 2'10", 3'0"	2'8", 2'10" 3'0"	2'6", 2'8" 2'10", 3'0"
7'0"	2'0", 2'6", 2'8" 2'10", 3'0"	-	-	-	2'6", 2'8" 2'10", 3'0"	-	2'6", 2'8" 2'10", 3'0"
8'0"	2'0", 2'6", 2'8" 2'10", 3'0"	-	2'8", 2'10" 3'0"	-	-	-	2'8", 2'10" 3'0"
fire door option	2'0", 2'6", 2'8" 2'10", 3'0"	2'8", 2'10" 3'0"	-	-	-	2'10", 3'0"	2'6", 2'8" 2'10", 3'0"
glass sizes	109, 120, 122 300, 810	106, 107	122	304 404, 410	105, 106, 107 135, 137	106	106, 120 122, 404, 810

	SHD	SHD	SHD	SHD	SHD	SHD
	8 P PARLAMENT	9 P CAMBER-TOP	FLUSH SIDEITE	1 P SIDEITE w/ 9 X 65 C/O	2 P UNIVERSAL SIDEITE	3 P SIDEITE
6'8"	2'8", 2'10" 3'0"	2'8", 2'10" 3'0"	10", 1'0", 1'2"	-	1'0", 1'2"	-
7'0"	-	-	1'0", 1'2"	-	1'0", 1'2"	-
8'0"	-	-	10", 1'0", 1'2"	1'0", 1'2"	-	1'0", 1'2"
fire door option	2'8", 2'10" 3'0"	2'8", 2'10" 3'0"	-	-	-	-
glass sizes	203	136	149, 151 152, 852	151	129, 200, 450	450, 852

Masonite® Utility Steel door series

Masonite Utility Steel unique features

■ **factory-primed surface**
superior protection against the elements (finishing required)

■ **standard panel profile**

■ **wood-edge construction**

■ **hot-dipped, galvanized, primed steel facings**

■ **composite bottom rail**
creates a rot and moisture resistant structure

LIMITED 1 YEAR WARRANTY (Wood-Edge)

	MUS	MUS	MUS	MUS	MUS
	FLUSH	4 P BLANK-TOP	6 P	FLUSH SIDEITE	2 P SIDEITE
6'8"	2'6", 2'8" 2'10", 3'0"	2'6", 2'8" 2'10", 3'0"	2'6", 2'8" 2'10", 3'0"	10", 1'0", 1'2"	1'0", 1'2"
7'0"	-	-	-	-	-
8'0"	-	-	-	-	-
glass sizes	109, 120 122, 300	105, 106, 107 135, 137	106 120, 122	149, 151, 152	129, 200

SHD Sta-Tru® HD Steel
MHD Masonite® HD Steel
MUS Masonite® Utility Steel

HD STEEL MHD 6 panel

Barrington® selection & style



Barrington Traditional unique features

- oak or mahogany texture**
options reflect state-of-the-art, variable-depth authentic hardwood appearance that finishes easily and beautifully
- distinct raised moulding**
– integrated into the facing (no plant-on applique)
– reminiscent of hand-crafted hardwood doors
- proprietary decorative glass design options** – CB1, BR1, BR2, or BR3
- custom glazing frames**
– match panel moulding
– architecturally correct alignment between glazing frame & panel moulding
- durability**
will not dent and resists splitting, cracking and warping

LIMITED LIFETIME WARRANTY

Barrington® Traditional fiberglass door series

	▼ 8 P PARLAMENT with center arch glass		▼ 1 P with full oval glass		▼ 2 P with 3/4 oval glass		▼ 2 P with 3/4 rectangular glass		▼ 3 P with 1/2 camber-top glass		▼ SIDELITE with full glass		▼ SIDELITE with 3/4 glass	
	BAR		BAR		BAR & BRM		BAR		BAR		BAR		BAR & BRM	
6'8"	3'0"		3'0"		3'0"		3'0"		3'0"		1'0", 1'2"		1'0", 1'2"	
8'0"	3'0", 3'6"		-		3'0", 3'6"		3'0", 3'6"		3'0", 3'6"		1'0", 1'2"		1'0", 1'2"	
glass options	6'8"	8'0"	6'8"	8'0"	6'8"	8'0"	6'8"	8'0"	6'8"	8'0"	6'8"	8'0"	6'8"	8'0"
BR1	204-BR1	205-BR1	301-BR1	-	303-BR1	302-BR1	405-BR1	123-BR1	411-BR1	412-BR1	154-BR1	853-BR1	451-BR1	153-BR1
BR2	204-BR2	205-BR2	301-BR2	-	303-BR2	302-BR2	405-BR2	123-BR2	411-BR2	412-BR2	154-BR2	853-BR2	451-BR2	153-BR2
BR3	204-BR3	205-BR3	301-BR3	-	303-BR3	302-BR3	405-BR3	123-BR3	411-BR3	412-BR3	154-BR3	853-BR3	451-BR3	153-BR3
CB1				-	303-CB1		405-CB1		411-CB1				451-CB1	

	circular transom	shoulder transom	elliptical transom	rectangular transom	halfcircle transom
compatible door unit sizes	1'0"-3'0"-1'0" & 1'2"-3'0"-1'2"				
BR1 transoms	-	-	-	-	-
BR2 transoms	-	S-900	E-900	T-900	C38-900
BR3 transoms	C-725	S-725	E-725	T-725	C38-725

Clear transoms are available

custom glass options

- BR1 brass caming
- BR2 antique black caming
- BR3 platinum caming
- CB1 clear beveled

BARRINGTON® CRAFTSMAN TEXTURED OAK with BC4 glass and applied dentil shelf BRC-225-BC4-3



Barrington Craftsman unique features

- oak or mahogany texture**
authentic hardwood options
- Mission/Craftsman style**
with three recessed panels
- custom glass**
options – BC4, BC5 or BS1
- factory-glazed with unique**
1 lite custom glazing system
- dentil shelf** option
- simulated divided lite kit (SDL)** option

LIMITED LIFETIME WARRANTY

Barrington® Craftsman fiberglass door series

	▼ 3 P CRAFTSMAN with 1 lite				▼ 3 P SIDELITE with 1 lite		
	BRC & BCM				BRC & BCM		
6'8"	3'0"				1'0", 1'2"		
dentil shelf kit	option shown				-		
SDL kit	-				option shown		
glass options	225-BC4	225-BC5	225-BS1*		609-BC4 / 609-BC5	609-BS1*	
glass caming	antique black				antique black		
					clear glass		

	shoulder transom	rectangular transom
compatible door unit sizes	1'0"-3'0"-1'0" & 1'2"-3'0"-1'2"	
BC4 transoms	-	T-366
BC5 transoms	S-315	T-315

Clear transoms are available

custom glass options

- BC4 antique black caming
- BC5 antique black caming
- BS1 clear glass

Barrington Sierra & Flagstaff unique features

- beautiful mahogany texture**
featuring a beige-colored fiberglass facing perfect for a Southwest, Spanish or Mediterranean look
- custom panel profile**
reproduces artisan construction
- subtle details in flagstaff**
incorporates elements of contemporary styling, while staying rooted in traditional cottage and rustic themes
- select designs are also available**
with AvantGuard™ Spanish Cedar or Black Walnut finishes

LIMITED LIFETIME WARRANTY

Barrington® Sierra™ & Flagstaff™ fiberglass door series

	▼ 2 P CAMBER-TOP		▼ 2 P CAMBER-TOP arch-top		▼ 1 P CAMBER-TOP plank		▼ 1 P CAMBER-TOP arch-top plank		▼ FLAGSTAFF plank		▼ SIDELITE with full BR1 glass		▼ SIDELITE with full BR2 glass		▼ SIDELITE with full BR3 glass		▼ SIDELITE with full BS1* glass			
	BSN		BSP		BSN		BSP		BSP		BFS		BR1		BR2		BR3		BS1*	
6'8"	3'0"		3'0"		3'0"		3'0"		3'0"		3'0"		1'0", 1'2"		1'0", 1'2"		1'0", 1'2"		1'0", 1'2"	
8'0"	3'0", 3'6"		3'0", 3'6"		3'0", 3'6"		3'0", 3'6"		3'0", 3'6"		3'0", 3'6"		1'0", 1'2"		1'0", 1'2"		1'0", 1'2"		1'0", 1'2"	
plank feature	no plank		plank		no plank		plank		plank		plank		-		-		-		-	
glass caming											brass		antique black		platinum		clear glass			

- BAR Barrington® Oak Textured
- BRM Barrington® Mahogany Textured
- BRC Barrington® Craftsman Oak Textured
- BCM Barrington® Craftsman Mahogany Textured
- BSN Barrington® Sierra™ No Plank
- BSP Barrington® Sierra™ Plank
- BFS Barrington® Flagstaff™ Plank

*Note: Upgrade BS1 clear glass to Low-E and Argon filled (LEA) to increase thermal performance and savings.

entry configuration options

BARRINGTON®
Fiberglass Entry Doors

fiberglass

selection & style



BLT Belleville® Oak Textured
 BMT Belleville® Mahogany Textured
 BLS Belleville® Smooth
 OAK Oakcraft®

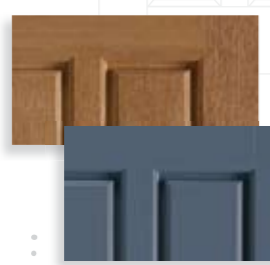

Belleville 6 panel camber-top
 features a custom shaker panel profile
 for additional architectural interest.

Specialty™ glass inserts

- premium decorative glass inserts feature a triple-pane 1" insulated glass assembly.
- clear and etched glass inserts feature double-pane insulated glass.
- flush-glazed also available.

BELLEVILLE® SMOOTH with Alston™ glass – door BLS-304-338-3 – sidelite BLSL-450-338-1

accentuating personal style

Belleville Textured unique features

- oak or mahogany variable-depth wood-grain texture** creates authentic hardwood appearance that finishes easily and beautifully
- high-performance fiberglass** provides maximum protection and durability that will not dent or rust and resists splitting, cracking and warping
- high-definition panel profile** creates excellent shadow lines and distinct panel designs
- engineered hinge and lock stiles** feature laminated lumber which provides excellent dimensional stability
- internal blocking** in lock area provides reinforcement and solid mounting surface for hardware
- true square-edge design** offers an authentic wood door appearance and permits easy field machining
- composite bottom rail** creates a rot and moisture resistant structure
- Belleville Mahogany** available in AvantGuard Black Walnut Finish

LIMITED LIFETIME WARRANTY

Belleville® Oak Textured & Mahogany Textured fiberglass door series

Door Style	6'8"	7'0"	8'0"	fire door option	glass sizes
BLT FLUSH	2'0", 2'6", 2'8" 2'10", 3'0"	-	2'0", 2'6", 2'8" 2'10", 3'0"	2'0", 2'6", 2'8" 2'10", 3'0"	109, 120, 122 300, 810
BLT 1/4" ARCH	2'8", 2'10" 3'0"	-	2'8", 2'10" 3'0"	-	306
BLT 1/2" SQUARE	2'8", 2'10" 3'0"	-	2'8", 2'10" 3'0"	-	106, 404
BLT 3/4" ARCH-TOP	2'8", 2'10" 3'0"	-	2'8", 2'10" 3'0"	-	304 404, 410
BLT 1" PARH-TOP	2'8", 2'10" 3'0"	-	2'8", 2'10" 3'0"	2'8", 2'10" 3'0"	105, 106, 107 135, 137, 228
BLT 1 1/4" BLANK-TOP	2'8", 2'10" 3'0"	-	2'8", 2'10" 3'0"	2'8", 2'10" 3'0"	106
BLT 1 1/2" NEW ENGLAND	2'8", 2'10" 3'0"	-	2'8", 2'10" 3'0"	-	105, 106, 107 135, 137, 228
BLT 1 3/4" BLANK-TOP	2'6", 2'8" 2'10", 3'0"	-	2'6", 2'8" 2'10", 3'0"	2'8", 2'10", 3'0"	106, 120, 122 228, 404, 810
BLT 1 3/4" CAMBER-TOP	2'8", 2'10" 3'0"	-	2'8", 2'10" 3'0"	-	137, 228
BLT 1 3/4" PARLAMENT	2'10", 3'0"	-	2'10", 3'0"	-	201, 203
BLT SIDELITE with full glass	1'0", 1'2"	1'0", 1'2"	1'0", 1'2"	-	149, 151 152, 852
BLT SIDELITE with 3/4 glass	1'0", 1'2"	-	1'0", 1'2"	-	152, 450
BLT SIDELITE with 1/2 glass	1'0", 1'2"	-	1'0", 1'2"	-	129, 450
BMT 1/2" HOLLISTER™	2'8", 2'10", 3'0"	-	2'8", 2'10" 3'0", 3'6"	3'0"	122, 304 306, 404
BMT 1/2" PARLAMENT	2'8", 2'10", 3'0"	-	2'8", 2'10" 3'0", 3'6"	-	106, 122, 228 404, 810
BMT SIDELITE with full glass	1'0", 1'2"	-	1'0", 1'2"	-	152, 852
BMT SIDELITE with 3/4 glass	1'0", 1'2"	-	1'0", 1'2"	-	450
BMT SIDELITE with 1/2 glass	1'0", 1'2"	-	1'0", 1'2"	-	129

Oakcraft Textured unique features

- wood-grain texture** yields a wood-like appearance and provides easy finishing
- high-performance fiberglass** provides maximum protection and durability that will not dent or rust and resists splitting, cracking and warping
- engineered hinge and lock stiles** feature laminated lumber which provides excellent dimensional stability
- internal blocking** in lock area provides reinforcement and solid mounting surface for hardware
- true square-edge design** offers an authentic wood door appearance and permits easy field machining
- composite bottom rail** creates a rot and moisture resistant structure

LIMITED 25 YEAR WARRANTY

Oakcraft® fiberglass door series

Door Style	6'8"	7'0"	8'0"	fire door option	glass sizes
OAK FLUSH	2'0", 2'6", 2'8" 2'10", 3'0"	-	2'0", 2'6", 2'8" 2'10", 3'0"	2'0", 2'6", 2'8" 2'10", 3'0"	109, 120, 122 300, 810
OAK 3/4" ARCH-TOP	2'8", 2'10" 3'0"	-	2'8", 2'10" 3'0"	-	304 404, 410
OAK 1" PARH-TOP	2'8", 2'10" 3'0"	-	2'8", 2'10" 3'0"	-	105, 106, 107 135, 137, 228
OAK 1 1/4" BLANK-TOP	2'6", 2'8" 2'10", 3'0"	-	2'6", 2'8" 2'10", 3'0"	2'8", 2'10" 3'0"	106, 120, 122 228, 404
OAK 1 1/2" NEW ENGLAND	2'8", 2'10" 3'0"	-	2'8", 2'10" 3'0"	-	136
OAK 1 3/4" BLANK-TOP	1'0", 1'0", 1'2" 1'0", 1'2"	1'0", 1'0", 1'2"	1'0", 1'0", 1'2"	-	149, 151 152, 852
OAK 1 3/4" NEW ENGLAND	1'0", 1'2"	-	1'0", 1'2"	-	450
OAK SIDELITE with full glass	1'0", 1'2"	1'0", 1'2"	1'0", 1'2"	-	129, 450
OAK SIDELITE with 3/4 glass	1'0", 1'2"	-	1'0", 1'2"	-	-
OAK SIDELITE with 1/2 glass	1'0", 1'2"	-	1'0", 1'2"	-	-

Belleville Smooth unique features

- incredibly smooth surface** ideal for painting and decorating
- high-performance fiberglass** provides maximum protection and durability that will not dent or rust and resists splitting, cracking and warping
- high-definition panel profile** creates excellent shadow lines and distinct panel designs
- engineered hinge and lock stiles** feature laminated lumber which provides excellent dimensional stability
- internal blocking** in lock area provides reinforcement and solid mounting surface for hardware
- true square-edge design** offers an authentic wood door appearance and permits easy field machining
- composite bottom rail** creates a rot and moisture resistant structure

LIMITED LIFETIME WARRANTY

Belleville® Smooth fiberglass door series

Door Style	6'8"	7'0"	8'0"	fire door option	glass sizes
BLS FLUSH	2'0", 2'6", 2'8" 2'10", 3'0"	-	2'0", 2'6", 2'8" 2'10", 3'0"	2'0", 2'6", 2'8" 2'10", 3'0"	109, 120, 122 300, 810
BLS 1/2" SQUARE	2'8", 2'10" 3'0"	-	2'8", 2'10" 3'0"	-	106, 404
BLS 1/2" CHERRINE	2'8", 2'10" 3'0"	-	2'8", 2'10" 3'0"	-	106, 107, 404
BLS 3/4" ARCH-TOP	2'8", 2'10" 3'0"	-	2'8", 2'10" 3'0"	-	304 404, 410
BLS 1" PARH-TOP	2'8", 2'10" 3'0"	-	2'8", 2'10" 3'0"	-	105, 106, 107 135, 137, 228
BLS 1 1/4" BLANK-TOP	2'8", 2'10" 3'0"	-	2'8", 2'10" 3'0"	2'8", 2'10" 3'0"	106
BLS 1 1/2" NEW ENGLAND	2'8", 2'10" 3'0"	-	2'8", 2'10" 3'0"	-	105, 106, 107 135, 137, 228
BLS 1 3/4" BLANK-TOP	2'6", 2'8" 2'10", 3'0"	-	2'6", 2'8" 2'10", 3'0"	2'8", 2'10" 3'0"	106, 120, 122 228, 404, 810
BLS 1 3/4" CAMBER-TOP	2'8", 2'10" 3'0"	-	2'8", 2'10" 3'0"	-	137, 228
BLS 1 3/4" PARLAMENT	2'10", 3'0"	-	2'10", 3'0"	-	201, 203
BLS SIDELITE with full glass	1'0", 1'0" 1'2"	1'0", 1'0", 1'2"	1'0", 1'2"	-	149, 151 152, 852
BLS SIDELITE with 3/4 glass	1'0", 1'2"	-	1'0", 1'2"	-	152, 450
BLS SIDELITE with 1/2 glass	1'0", 1'2"	-	1'0", 1'2"	-	129, 450

† Features narrow panel layout. * 6 panel Camber-top features a straight-grain hardwood texture.
 ‡ Available as 20-minute Warnock-Hersey® listed fire door (features an engineered solid core). Fire door option only available for 6'8" and 7'0" doors.



Design flexibility



BELLEVILLE®
 Fiberglass Entry Doors

Oakcraft®
 Wood-grain Textured
 FIBERGLASS ENTRY DOORS

staining textured wood-grain doors

Staining your fiberglass entry system has never been easier. The fiberglass staining kit from Masonite comes with everything you need to achieve a high-quality finish.



complete stain kit

- ZAR® exterior water-based polyurethane (Qt.)
- ZAR wood stain (Pt.)
- mineral spirits (4 oz.)
- one synthetic bristle brush (2-1/2")
- two foam brushes (2")
- two stir sticks
- one pair of latex gloves
- cheese cloths
- door staining instructions

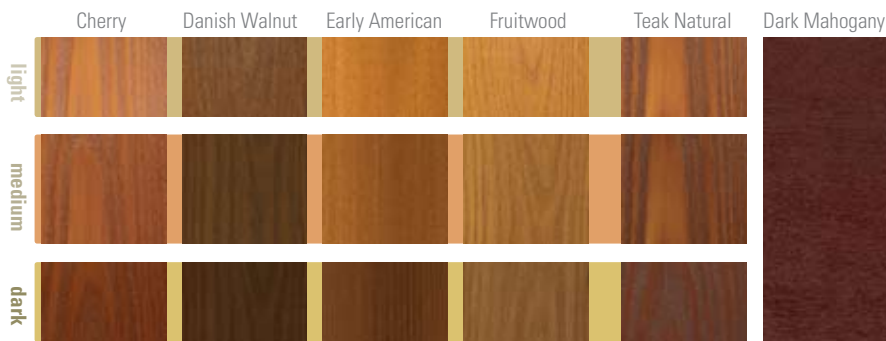

Stain colors are approximate and may vary in actuality to printed materials.

Masonite Tested

Masonite has tested many competing stain and topcoat systems for ease of application, finish quality, and durability and highly recommends the ZAR system.

Conveniently Packaged

For your convenience we have pre-packaged all the supplies you need to finish your Barrington, Belleville, or Oakcraft door into one convenient kit.

Beautiful Finish

Choose from six distinct colors and customize the shade of your door from light to dark to suit your needs. Finish the project by applying the UV resistant clear satin polyurethane for years of protection and beauty.



BAR-303-BR1-2

BRM-303-BR1-2

BLT-203-900-7

BMT-404-957-1

OAK-304-328-3

inspired by people

designed with precision

MASONITE. THE BEAUTIFUL DOOR.®

At Masonite, we remain relentlessly committed to delivering product, service and design innovations that enhance beauty and functionality. These innovations create greater value for our customers throughout the world – innovations that will make your home more beautiful.

Our leadership and superior products have earned us a reputation that is unsurpassed in the industry.

So, when it comes to quality, innovation, value, design and beauty, you can confidently put your trust in Masonite. The Beautiful Door.®

BELLEVILLE® HOLLISTER™ MAHOGANY TEXTURED with Element™ glass BVI-1-404-328-1



BARRINGTON® FLAGSTAFF™ with AvantiGuard™ Spanish Cedar finish BAC-1P



BARRINGTON® SIERRA 2 panel (amber-top) with AvantiGuard™ Black Walnut finish BAV-2



www.masonite.com



BARRINGTON® OAK TEXTURED with BR2 glass

BARRINGTON® CRAFTSMAN MAHOGANY TEXTURED with clear glass

BELLEVILLE® HOLLISTER® MAHOGANY TEXTURED with Alison glass

HO STEEL 2 panel (amber-top plank)

BARRINGTON® FLAGSTAFF™ with AvantGuard™ Black Walnut finish

BELLEVILLE® SMOOTH with Monaco™ glass

BELLEVILLE® MAHOGANY TEXTURED with Element™ glass

BARRINGTON® SIERRA™ with AvantGuard Spanish Cedar finish

BELLEVILLE® HOLLISTER® MAHOGANY TEXTURED with Quattro™ glass

Masonite's Commitment

At Masonite, employees from all parts of the Company – sales, marketing, research and development, customer service and manufacturing – understand that people love their homes. In the past, homes were purchased to meet functional needs. Today, homes are purchased to meet specific lifestyles and to satisfy the need to create multiple living environments within a single home. To meet these lifestyle needs, Masonite is continually creating new and innovative products that will make every home more beautiful, more valuable and more enjoyable. With the ultimate goal of adding beauty and value to every home, Masonite's products are designed and constructed to exacting standards and specifications. All materials – wood, fiberglass, steel or composites – are engineered and carefully selected to ensure lasting durability and performance. For individuals who are building, renovating or redecorating, Masonite products are certain to beautify and accentuate a wide array of architectural home styles.

 *Masonite*®
the beautiful **door**™

Masonite®, "Masonite. The Beautiful Door.®," AvantGuard®, Barrington®, Belleville®, Cheyenne®, Flagstaff®, Hollister®, Oakcraft®, Sierra®, Sta-Tru®, Specialty®, Alston®, Aria®, Aurora®, Chandler®, Element®, Fundy®, Georgian®, Glace®, Jasmine®, Madrid®, Marquise®, Monaco®, Mondrian®, Naples®, Navarro®, Oxford®, Panama®, Piedmont®, Quattro®, Riviera®, Sienna®, SpectraWeld®, Trella®, Victorian®, Woodbridge™ and Zavalla®, Centurion™, U-Install®, Seal-rite™ and Fast-Frame™ are trademarks of Masonite International Corporation. Please check with your Masonite dealer or distributor for current warranty terms and conditions. Our continuing program of product improvement makes specification, design and product detail subject to change without notice.

860077 12/09 PRINTED IN THE USA ©2009 by Masonite International Corporation

